



OFFICIAL BEACH VOLLEYBALL RULES 2021-2024

Approved by the 37th FIVB World Congress 2021

Official Beach Volleyball Rules 2021-2024

Published by FIVB in 2021 – www.fivb.com

Design, layout and illustrations: © FIVB 2021



OFFICIAL BEACH VOLLEYBALL RULES 2021-2024

Approved by the 37th FIVB World Congress 2021

To be implemented in all competitions from 1st January 2022

CONTENTS

GAME CHARACTERISTICS	7
PART 1: PHILOSOPHY OF RULES AND REFEREEING	8
PART 2 - SECTION 1: GAME	11
CHAPTER 1: FACILITIES AND EQUIPMENT	12
1 PLAYING AREA	12
1.1 DIMENSIONS.....	12
1.2 PLAYING SURFACE	12
1.3 LINES ON THE COURT	13
1.4 ZONES AND AREAS.....	13
1.5 WEATHER	13
1.6 LIGHTING.....	13
2 NET AND POSTS	13
2.1 HEIGHT OF THE NET.....	13
2.2 STRUCTURE	14
2.3 SIDE BANDS.....	14
2.4 ANTENNAE	14
2.5 POSTS.....	15
2.6 ADDITIONAL EQUIPMENT	15
3 BALLS.....	15
3.1 STANDARDS	15
3.2 UNIFORMITY OF BALLS	15
3.3 FOUR-BALL SYSTEM.....	15
CHAPTER 2: PARTICIPANTS	16
4 TEAMS	16
4.1 TEAM COMPOSITION.....	16
4.2 LOCATION OF THE TEAM.....	16
4.3 EQUIPMENT	16
4.4 CHANGE OF EQUIPMENT.....	17
4.5 FORBIDDEN OBJECTS	17
5 TEAM LEADERS	17
5.1 CAPTAIN.....	17

CHAPTER 3: PLAYING FORMAT 19

6 TO SCORE A POINT, TO WIN A SET AND THE MATCH..... 19

6.1 TO SCORE A POINT.....19

6.2 TO WIN A SET.....20

6.3 TO WIN THE MATCH.....20

6.4 DEFAULT AND INCOMPLETE TEAM.....20

7 STRUCTURE OF PLAY 20

7.1 THE TOSS.....20

7.2 OFFICIAL WARM-UP SESSION.....21

7.3 TEAM LINE-UP21

7.4 POSITIONS21

7.5 POSITIONAL FAULT.....21

7.6 SERVICE ORDER.....21

7.7 SERVICE ORDER FAULT.....21

CHAPTER 4: PLAYING ACTIONS 22

8 STATES OF PLAY 22

8.1 BALL IN PLAY22

8.2 BALL OUT OF PLAY22

8.3 BALL “IN”22

8.4 BALL “OUT”22

9 PLAYING THE BALL 23

9.1 TEAM HITS.....23

9.2 CHARACTERISTICS OF THE HIT24

9.3 FAULTS IN PLAYING THE BALL24

10 BALL AT THE NET.....24

10.1 BALL CROSSING THE NET.....24

10.2 BALL TOUCHING THE NET.....25

10.3 BALL IN THE NET.....25

11 PLAYER AT THE NET.....25

11.1 REACHING BEYOND THE NET25

11.2 PENETRATION INTO THE OPPONENT’S SPACE, COURT AND/OR FREE ZONE25

11.3 CONTACT WITH THE NET.....25

11.4 PLAYER’S FAULTS AT THE NET26

12 SERVICE26

12.1 FIRST SERVICE IN A SET.....26

12.2 SERVICE ORDER.....26

12.3 AUTHORIZATION OF THE SERVICE.....27

12.4 EXECUTION OF THE SERVICE27

12.5	SCREENING.....	27
12.6	FAULTS MADE DURING THE SERVICE	27
13	ATTACK HIT.....	28
13.1	CHARACTERISTICS OF THE ATTACK HIT	28
13.2	FAULTS OF THE ATTACK HIT	28
14	BLOCK	28
14.1	BLOCKING	28
14.2	BLOCK CONTACT	29
14.3	BLOCKING WITHIN THE OPPONENT’S SPACE.....	29
14.4	BLOCK AND TEAM HITS.....	29
14.5	BLOCKING THE SERVICE	29
14.6	BLOCKING FAULTS.....	29

CHAPTER 5: INTERRUPTIONS, DELAYS AND INTERVALS	30
---	-----------

15	INTERRUPTIONS.....	30
15.1	NUMBER OF REGULAR GAME INTERRUPTIONS	30
15.2	SEQUENCE OF REGULAR GAME INTERRUPTIONS	30
15.3	REQUEST FOR REGULAR GAME INTERRUPTIONS	30
15.4	TIME-OUTS AND TECHNICAL TIME-OUTS.....	30
15.5	IMPROPER REQUESTS.....	31
16	GAME DELAYS	31
16.1	TYPES OF DELAYS	31
16.2	DELAY SANCTIONS	31
17	EXCEPTIONAL GAME INTERRUPTIONS	32
17.1	INJURY/ ILLNESS.....	32
17.2	EXTERNAL INTERFERENCE	32
17.3	PROLONGED INTERRUPTIONS	32
18	INTERVALS AND CHANGE OF COURTS/SWITCHES.....	33
18.1	INTERVALS	33
18.2	COURT SWITCHES	33

CHAPTER 6: PARTICIPANTS' CONDUCT 34

19 REQUIREMENTS OF CONDUCT 34
 19.1 SPORTSMANLIKE CONDUCT 34
 19.2 FAIR PLAY 34
20 MISCONDUCT AND ITS SANCTIONS 34
 20.1 MINOR MISCONDUCT 34
 20.2 MISCONDUCT LEADING TO SANCTIONS 35
 20.3 SANCTION SCALE 35
 20.4 MISCONDUCT BEFORE AND BETWEEN SETS 35
 20.5 SUMMARY OF MISCONDUCT AND CARDS USED 36

PART 2 - SECTION 2: THE REFEREES, THEIR RESPONSIBILITIES AND OFFICIAL HAND SIGNALS 37

CHAPTER 7: REFEREES 38

21 REFEREEING TEAM AND PROCEDURES 38
 21.1 COMPOSITION 38
 21.2 PROCEDURES 38
22 1st REFEREE 39
 22.1 LOCATION 39
 22.2 AUTHORITY 39
 22.3 RESPONSIBILITIES 40
23 2nd REFEREE 40
 23.1 LOCATION 40
 23.2 AUTHORITY 40
 23.3 RESPONSIBILITIES 41
24 CHALLENGE REFEREE 42
 24.1 LOCATION 42
 24.2 RESPONSIBILITIES 42
25 RESERVE REFEREE 42
 25.1 LOCATION 42
 25.2 RESPONSIBILITIES 42
26 SCORER 43
 26.1 LOCATION 43
 26.2 RESPONSIBILITIES 43
27 ASSISTANT SCORER 44
 27.1 LOCATION 44
 27.2 RESPONSIBILITIES 44

28	LINE JUDGES	44
28.1	LOCATION	44
28.2	RESPONSIBILITIES	45
29	OFFICIAL SIGNALS	45
29.1	REFEREES' HAND SIGNALS	45
29.2	LINE JUDGES' FLAG SIGNALS	45

PART 2 - SECTION 3: DIAGRAMS **47**

D1	THE PLAYING AREA	48
D2	THE PLAYING COURT	49
D3	DESIGN OF THE NET	50
D4a	BALL CROSSING THE VERTICAL PLANE OF THE NET TO THE OPPONENT COURT	51
D4b	BALL CROSSING THE VERTICAL PLANE OF THE NET TO THE OPPONENT FREE ZONE	52
D5	SCREEN	53
D6	COMPLETED BLOCK	53
D7	DETERRENTS AND SANCTIONS	54
D7a	MISCONDUCT WARNING AND SANCTIONS SCALE AND THEIR CONSEQUENCES	54
D7b	DELAY SANCTIONS SCALE AND CONSEQUENCES	54
D8	LOCATION OF REFEREEING TEAM AND THEIR ASSISTANTS	55
D9	REFEREES' OFFICIAL HAND SIGNALS	56-62
D10	LINE JUDGES' OFFICIAL FLAG SIGNALS	63-64

PART 3: DEFINITIONS **65**

INDEX **68**





GAME CHARACTERISTICS

Beach Volleyball is a sport played by two teams on a sand court divided by a net.

The team has three hits for returning the ball (including the block touch).

In Beach Volleyball, the team winning a rally scores a point (Rally Point System). When the receiving team wins a rally, it gains a point and the right to serve. The serving player must be alternated every time this occurs.

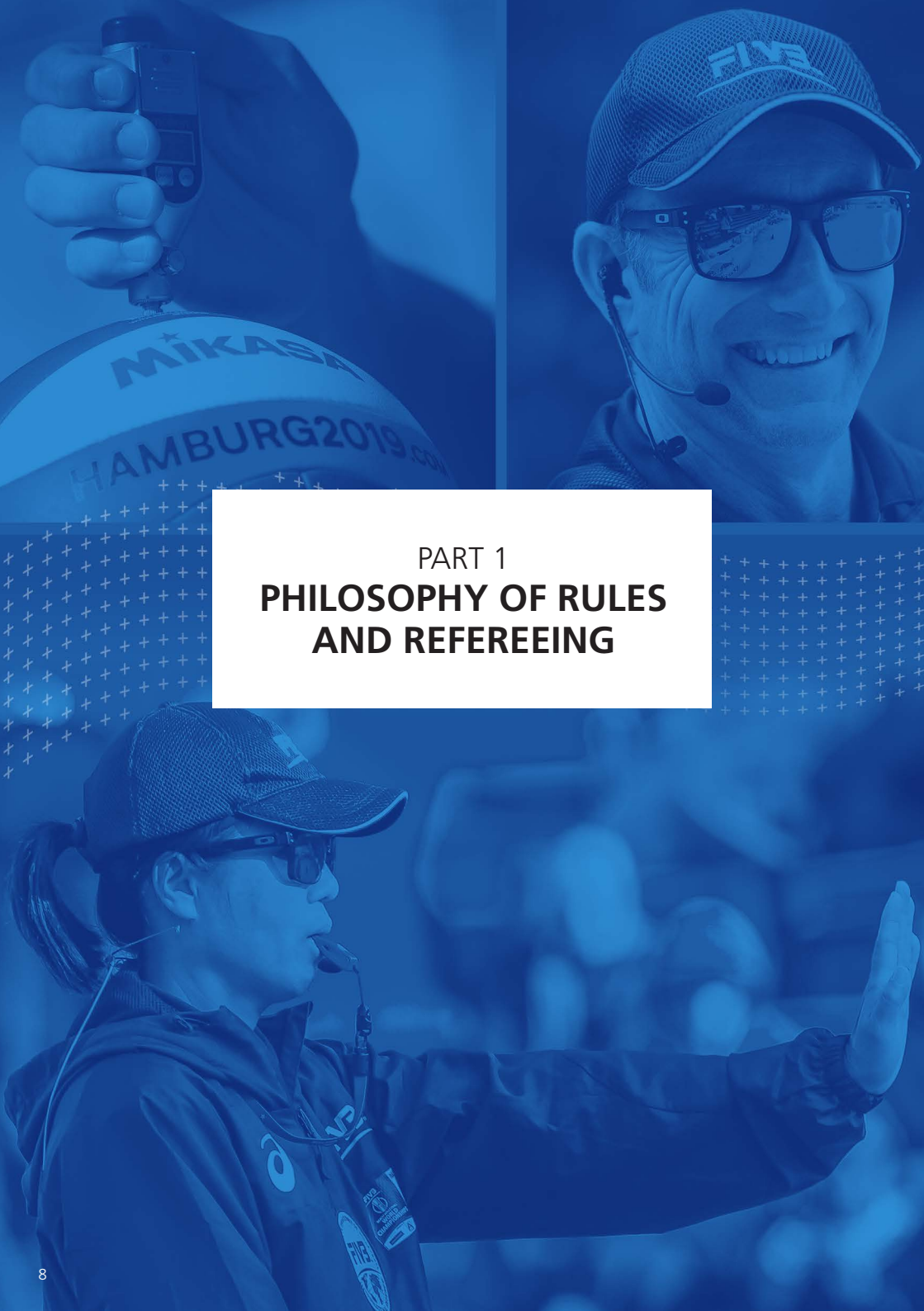

PART 1
**PHILOSOPHY OF RULES
AND REFEREEING**

INTRODUCTION

By every measure, Beach Volleyball is one of the world's most successful and popular sports – it has larger TV viewing figures, larger followers on social media, greater (and growing) numbers of registered and recreational players, than almost any other sport, and an image which is dynamic, clean and colorful, combining, especially at the competitive levels, a visual and audible feast to satisfy every palate.

Put simply, it is **fast**, it is **exciting** and the action is **explosive**. Yet the Beach form of Volleyball comprises several crucial overlapping elements whose complimentary **interactions** render it unique amongst rally games, and create a special charm to differentiate it from other forms of the sport.

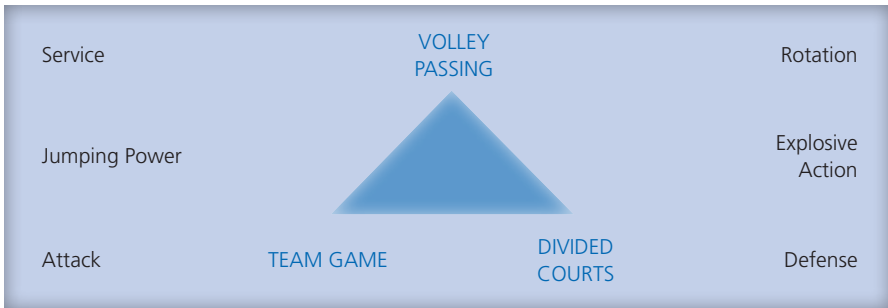

FIVB BEACH VOLLEYBALL IS A COMPETITIVE SPORT

Competition taps latent strengths. It exhibits the best of ability, spirit, creativity and aesthetics. The rules are structured to allow **all** of these qualities. The game's early exponents on the sands of California would still recognize it. Yet, in recent years the FIVB has made great strides in adapting the game to a modern audience.

In this regard, Beach Volleyball has retained certain distinctive and essential elements over the years. Some of these it shares with other net/ball/ racquet games: – Service – Rotation (taking turns to serve) – Attack – Defense – players able to play anywhere on court.

But the sport has moved on. Today it is more explosive, and more spectacular. It is fast and free flowing; it has athletic players doing sensational things on court in crowded venues. Additionally, Beach Volleyball is unique amongst net games in insisting that the ball is in constant flight – a flying ball – and by allowing each team a degree of internal passing before the ball must be returned to the opponents, creating a kind sharing of the ball to produce equal opportunities for scoring points. In recent years the FIVB has made a massive investment in the use of technology, with its Video Challenge System providing fairness to the efforts of the athletes, and encouraging philosophies which promote flowing play to entertain the public, both in the venue and on the screen. Competitors use this framework to contest techniques, tactics and power. The framework also allows players a freedom of expression to enthuse spectators and viewers, and create an unrivaled sporting spectacle.

And the image of Beach Volleyball is increasingly a good one as a consequence.

THE RULES TEXT

This text is aimed at a broad Beach Volleyball public – players, coaches, referees, spectators, commentators, and others – because an understanding of the rules allows better play and personal satisfaction – coaches can create better team structure and tactics, giving players full rein to display their skills. Additionally, an understanding of the relationship between written rules and actual actions on the court allows officials to make better decisions.

Beach Volleyball is both recreational and competitive. Recreational sport taps into the human spirit and promotes “fun” and healthy life. Competition allows people to exhibit the best of ability, creativity, freedom of expression and fighting spirit. The rules are designed and structured to allow all of these facets to flourish.

This introduction has at first focused on Beach Volleyball as a competitive sport, before setting out to identify the main qualities required for successful refereeing.

THE REFEREE WITHIN THIS FRAMEWORK

The essence of a good official lies in the concept of fairness and consistency:

Being positioned in the middle of both playing courts is a symbol of balance, encouraging the players to trust the referee’s actions. However, the referee must be a facilitator rather than a controller, an orchestra director rather than a dictator, an efficient promoter rather than an “efficient” punisher.

By understanding the reason why a rule has been written and by being clear about its purpose within the framework of the “show”, the referee becomes a big part of the overall successful production, while remaining largely in the background and intervening only when necessary. We can say that a good referee will use the rules to make the competition a fulfilling experience for all concerned.

To those who have read thus far, view the rules which follow as the current state of development of a great game, but keep in mind why these preceding few paragraphs may be of equal importance to you in your own position within the sport. So...

Get involved !
Keep the ball flying !
Understand the game !

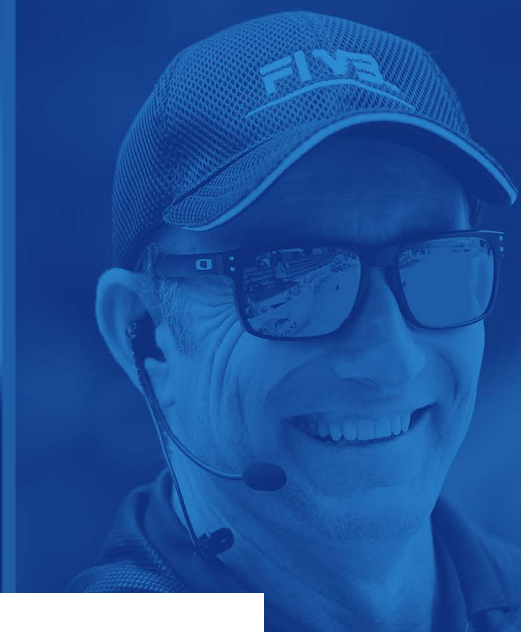

PART 2
SECTION 1: **GAME**



CHAPTER 1 FACILITIES AND EQUIPMENT

See Rules

1 PLAYING AREA

The playing area includes the playing court and the free zone. It shall be rectangular and symmetrical.

1.1, D1

1.1 DIMENSIONS

1.1.1 The playing court is a rectangle measuring 16 x 8 m, surrounded by a free zone, which is a minimum of 3 m wide on all sides.

D2

The free playing space is the space above the playing area, which is free from all obstructions. The free playing space shall measure a minimum of 7 m in height from the playing surface.

1.1.2 **For FIVB, World and Official Competitions, the free zone is a minimum of 5 m and a maximum of 6 m from the end lines/side lines. The free playing space shall measure a minimum of 12.5 m in height from the playing surface.**

1.2 PLAYING SURFACE

1.2.1 The surface must be composed of levelled sand, as flat and uniform as possible, free of rocks, shells and anything else which can represent risks of cuts or injuries to the players.

1.2.2 **For FIVB, World and Official Competitions, the sand must be at least 40 cm deep and composed of fine loosely compacted grains.**

1.2.3 The playing surface must not present any danger of injury to the players.

1.2.4 **For FIVB, World and Official Competitions, the sand should also be sifted to an acceptable size, not too coarse, and free of stones and dangerous particles. It should not be too fine to cause dust and stick to the skin.**

1.2.5 **For FIVB, World and Official Competitions, a tarp to cover the central court is recommended in case of rain.**

1.3 LINES ON THE COURT

1.3.1 All lines are 5 cm wide. The lines must be of a colour which contrasts sharply with the colour of the sand.

1.3.2 Boundary lines

Two side lines and two end lines mark the playing court. There is no centre line. Both side and end lines are placed inside the dimensions of the playing court.

Court lines should be ribbons made of a resistant material, and any exposed anchors should be of a soft, flexible material.

1.4 ZONES AND AREAS

There is only the playing court, service zone and the free zone surrounding the playing court.

1.4.1 The service zone is an 8 m wide area behind the end line, which extends to the edge of the free zone.

1.5 WEATHER

The weather must not present any danger of injury to the players.

1.6 LIGHTING

For FIVB, World and Official Competitions, played at night, the lighting on the playing area should be 1,000 to 1,500 lux measured at 1 m above the surface of the playing area.

2 NET AND POSTS

2.1 HEIGHT OF THE NET

2.1.1 Placed vertically over the middle of the court there is a net whose top is set at the height of 2.43 m for men and 2.24 m for women.

Note: The height of the net may be varied for specific age groups as follows:

Age Groups	Females	Males
16 years and under	2.24 m	2.24 m
14 years and under	2.12 m	2.12 m
12 years and under	2.00 m	2.00 m

2.1.2 Its height is measured from the centre of the playing court with a measuring rod. The net height (over the two side lines) must be exactly the same and must not exceed the official height by more than 2 cm.

2.2 STRUCTURE

The net is 8.5 m long and 1 m (+/- 3 cm) wide when it is hung taut, placed vertically over the narrow axis at the middle of the playing court.

It is made of 10 cm square mesh. At its top and bottom there are two 7-10 cm wide horizontal bands made of two-fold canvas, preferably in dark blue or bright colours, sewn along its full length. Each extremity of the upper band has a hole through which passes a cord fastening the upper band to the posts to keep the top of the net stretched taut.

Within the bands, there is a flexible cable in the upper one and a cord in the bottom one for fastening the net to the posts and keeping its top and bottom taut. It is permissible to have advertising on the horizontal bands of the net.

For FIVB, World and Official Competitions, an 8.0 m net with smaller meshes and brandings displayed between the ends of the net and the posts may be used, provided that the visibility of the athletes and officials will be preserved. Publicity may be printed on the above items as per FIVB regulations.

2.3 SIDE BANDS

Two coloured bands, 5 cm wide (same width as the court lines) and 1 m long, are fastened vertically to the net and placed directly above each side line. They are considered as part of the net.

Advertising is permitted on the side bands.

2.4 ANTENNAE

An antenna is a flexible rod, 1.80 m long and 10 mm in diameter, made of fibreglass or similar material.

An antenna is fastened at the outer edge of each side band. The antennae are placed on opposite sides of the net.

The top 80 cm of each antenna extends above the net and is marked with 10 cm stripes of contrasting colour, preferably red and white.

The antennae are considered as part of the net and laterally delimit the crossing space.

D3

14.1.1, D3

2.5 POSTS

- 2.5.1 The posts supporting the net are placed at a distance of 0.70-1.00 m outside each side line. They are 2.55 m high and preferably adjustable.

For FIVB, World and Official Competitions, the posts supporting the net are placed at a distance of 1 m outside the side lines.

- 2.5.2 The posts are rounded and smooth, fixed to the ground without wires. There shall be no dangerous or obstructing devices. Posts must be padded.

2.6 ADDITIONAL EQUIPMENT

All additional equipment is determined by FIVB regulations.

3 BALLS**3.1 STANDARDS**

The ball shall be spherical, made of a flexible material (leather, synthetic leather, or similar) which does not absorb moisture, i.e. more suitable to outdoor conditions since matches can be played when it is raining. The ball has a bladder inside made of rubber or a similar material. Approval of synthetic leather material is determined by FIVB regulations.

Colour: light uniform colour or a combination of colours.

Circumference: 66 to 68 cm.

Weight: 260 to 280 g.

Inside pressure: 0.175 to 0.225 kg/cm² (171 to 221 mbar or hPa).

3.2 UNIFORMITY OF BALLS

All balls used in a match must have the same standards regarding circumference, weight, pressure, type, colour, etc.

FIVB, World and Official Competitions must be played with FIVB approved balls, unless by agreement of FIVB.

3.3 FOUR-BALL SYSTEM

For FIVB, World and Official Competitions, four balls shall be used. In this case, six ball retrievers are stationed one at each corner of the free zone and one behind each referee.

D2, D3

3.2

3.1, 23.2.8

D8

CHAPTER 2 PARTICIPANTS

See Rules

4 TEAMS

4.1 TEAM COMPOSITION

- 4.1.1 A team is composed exclusively of two players.
- 4.1.2 Only the two players recorded on the score sheet have the right to participate in the match.
- 4.1.3 One of the players is the team captain who shall be indicated on the score sheet.
- 4.1.4 **For FIVB, World and Official Competitions, players are not allowed to receive external assistance or coaching during a match (Exceptions: see Specific Regulations for Age Competitions and for Phases 1 and 2 of the Continental Cup).**

4.2 LOCATION OF THE TEAM

The team's areas (including two chairs each) must be 5 m from the sideline, and no closer than 3 m from the scorer's table.

4.3 EQUIPMENT

A player's equipment consists of shorts or a bathing suit. A jersey or "tank-top" is optional except when specified in Tournament Regulations. Players may wear a hat/head covering.

- 4.3.1 **For FIVB, World and Official Competitions, players of a given team must wear uniforms of the same colour and style according to tournament regulations. Player's uniforms must be clean.**
- 4.3.2 Players must play barefoot except when authorized by the 1st referee.
- 4.3.3 Players' jerseys (or shorts if players are allowed to play without shirt) must be numbered 1 and 2.
 - 4.3.3.1 The number must be placed on the chest (or on the front of the shorts).
 - 4.3.3.2 The number must be of a contrasting colour to the jersey and a minimum of 10 cm in height. The stripe forming the number shall be a minimum of 1.5 cm wide.

4.1.1

4.4 CHANGE OF EQUIPMENT

If both teams arrive at a match dressed in jerseys of the same colour, a toss shall be conducted to determine which team shall change.

The first referee may authorize one or more players:

- 4.4.1 to play with socks and/or shoes,
- 4.4.2 to change wet jerseys between sets provided that the new ones also follow tournament and FIVB regulations.
- 4.4.3 If requested by a player, the first referee may authorize him/her to play with an undershirt and training pants.

4.3.3

4.5 FORBIDDEN OBJECTS

- 4.5.1 It is forbidden to wear objects which may cause injury or give an artificial advantage to the player.
- 4.5.2 Players may wear glasses or lenses at their own risk.
- 4.5.3 Compression pads (padded injury protection devices) may be worn for protection or support.

For FIVB, World and Official Competitions for seniors, these devices or visible underwear must be of the same colour as part of the uniform.

Black, white or neutral colours may be also used provided that all using players wear the same colour.

5 TEAM LEADERS

The team captain is responsible for maintaining team conduct and discipline.

5.1 CAPTAIN

- 5.1.1 PRIOR TO THE MATCH, the team captain:
 - a) Signs the score sheet.
 - b) Represents his/her team in the toss.
- 5.1.2 During the match, only the captain is authorized to speak to the referees while the ball is out of play in the following three cases:
 - 5.1.2.1 to ask for an explanation on the application or interpretation of the Rules; if the explanation does not satisfy the captain, the captain must immediately inform the 1st referee of his/her wish to Protest;

8.2

- 5.1.2.2 to ask authorization:
 - a) to change uniforms or equipment,
 - b) to verify the number of the serving player,
 - c) to check the net, the ball, the surface etc.,
 - d) to realign a court line;

- 5.1.2.3 to request time-outs.

15.2.1, 15.4.1

Note: the players must have authorization from the referees to leave the playing area.

- 5.1.3 AT THE END OF THE MATCH:

- 5.1.3.1 Both players thank the referees and the opponents. The Captain signs the score sheet to ratify the result;

- 5.1.3.2 If the captain previously requested a Protest Protocol via the 1st referee and this has not been successfully resolved at the time of the occurrence, he/she has the right to confirm it as a formal written protest, recorded on the score sheet at the end of the match.

5.1.2.1



CHAPTER 3

PLAYING FORMAT

See Rules

6 TO SCORE A POINT, TO WIN A SET AND THE MATCH

6.1 TO SCORE A POINT

6.1.1 Point

A team scores a point:

6.1.1.1 by successfully landing the ball on the opponent's court;

D9 (14)

6.1.1.2 when the opponent team commits a fault;

6.1.1.3 when the opponent team receives a penalty.

6.1.2 Fault

A team commits a fault by making a playing action contrary to the rules (or by violating them in some other way). The referees judge the faults and determine the consequences according to the rules:

6.1.2.1 if two or more faults are committed successively, only the first one is counted;

6.1.2.2 if two or more faults are committed by opponents simultaneously, a **DOUBLE FAULT** is called and the rally is replayed.

D9 (23)

6.1.3 Rally and completed rally

A **rally** is the sequence of playing actions from the moment of the service hit by the server until the ball is out of play. A **completed rally** is the sequence of playing actions which results in the award of a point. This includes:

8.1, 8.2,
12.2.2.1,
12.4.4,
22.3.2.2

- **the award of a penalty**
- **loss of service for a service hit made after the time-limit.**

6.1.3.1 If the serving team wins a rally, it scores a point and continues to serve.

6.1.3.2 If the receiving team wins a rally, it scores a point and it must serve next.

6.2 TO WIN A SET

A set (except the deciding 3rd set) is won by the team which first scores 21 points with a minimum lead of two points. In the case of a 20-20 tie, play is continued until a two-point lead is achieved (22-20; 23-21; etc).

D9 (9)

6.3 TO WIN THE MATCH

6.3.1 The match is won by the team that wins two sets.

D9 (9)

6.3.2 In the case of a 1-1 tie, the deciding 3rd set is played to 15 points with a minimum lead of 2 points.

6.4 DEFAULT AND INCOMPLETE TEAM

6.4.1 If a team refuses to play after being summoned to do so, it is declared in default and forfeits the match with the result 0-2 for the match and 0-21, 0-21 for each set.

6.4.2 A team that does not appear on the playing court on time is declared in default.

6.4.1

6.4.3 A team that is declared INCOMPLETE for the set or for the match, loses the set or the match. The opponent team is given the points, or the points and the sets, needed to win the set or the match. The incomplete team keeps its points and sets.

6.2, 6.3, 7.3.1

For FIVB, World and Official Competitions, whenever the Pool Play format is implemented, Rule 6.4 above may be subject to modifications as stated in the Specific Competition Regulations issued by the FIVB in due time, establishing the modality to be followed for treating the default and incomplete team cases.

7 STRUCTURE OF PLAY

7.1 THE TOSS

Before the official warm up, the 1st referee conducts the toss to decide upon the first service and the sides of the court in the first set.

7.1.1 The toss is taken in the presence of the two team captains, where appropriate.

7.1.2 The winner of the toss chooses:

EITHER

7.1.2.1 the right to serve or to receive the service,

OR

7.1.2.2 the side of the playing court.

The loser takes the remaining choice.

7.1.2.3 In the second set the loser of the toss in the first set will have the choice of 7.1.2.1 or 7.1.2.2.

A new toss will be conducted for the deciding set.

7.2 OFFICIAL WARM-UP SESSION

Prior to the match, if the teams have previously had another playing court at their disposal, they will have a 3-minute official warm-up period at the net; if not, they may have 5 minutes.

7.3 TEAM LINE-UP

7.3.1 Both players of each team must always be in play.

4.1.1

7.4 POSITIONS

At the moment the ball is hit by the server, each team must be within its own court (except the server).

7.4.1 The players are free to position themselves. There are NO determined positions on the court.

7.5 POSITIONAL FAULT

7.5.1 There are NO positional order faults.

7.6 SERVICE ORDER

7.6.1 Service order must be maintained throughout the set (as determined by the team captain immediately following the toss).

7.6.2 When the receiving team has gained the right to serve, its players "rotate" one position.

7.7 SERVICE ORDER FAULT

7.7.1 A service order fault is committed when the service is not made according to the service order. The team is sanctioned with a point and service to the opponent.

D9 (13)

7.7.2 The scorer(s) must correctly indicate the service order and correct any incorrect server prior to the whistle for service.

CHAPTER 4 PLAYING ACTIONS

		See Rules
8	STATES OF PLAY	
8.1	BALL IN PLAY	
	The ball is in play from the moment of the hit of the service authorized by the 1 st referee.	12, 12.3
8.2	BALL OUT OF PLAY	
	The ball is out of play at the moment of the fault which is whistled by one of the referees; in the absence of a fault, at the moment of the whistle.	
8.3	BALL "IN"	
	The ball is "in" if at any moment of its contact with the playing surface, some part of the ball touches the court, including touching the boundary lines.	D9 (14), D10 (1)
8.4	BALL "OUT"	
	The ball is "out" when it:	
8.4.1	falls on the ground completely outside the boundary lines (without touching them);	1.3.2, D9 (15), D10 (2)
8.4.2	touches an object outside the court, or a person out of play;	D9 (15), D10 (4)
8.4.3	touches the antennae, ropes, posts or the net itself outside the side bands;	2.3, D3, D4a, D9 (15), D10 (4)
8.4.4	crosses the vertical plane of the net either partially or totally outside the crossing space during service or during the third hit of the team (exception: Rule 10.1.2).	2.3, 10.1.2, D4a, D9 (15), D10 (4)
8.4.5	crosses completely the lower space under the net.	D4a, D9 (22)

9 PLAYING THE BALL

Each team must play within its own playing area and playing space (except Rule 10.1.2).

10.1.2

The ball may, however, be retrieved from beyond its own free zone and over the scoring table in its complete extension.

9.1 TEAM HITS

A hit is any contact with the ball by a player in play.

Each team is entitled to a maximum of three hits for returning the ball over the net. If more are used, the team commits the fault of "FOUR HITS".

These team hits include not only intentional hits by the player, but also unintentional contacts with the ball.

9.1.1 CONSECUTIVE CONTACTS

A player may not hit the ball two times consecutively (exceptions, see Rules: 9.2.2.2, 9.2.2.3, 14.2 and 14.4.2).

9.2.2.1, 14.2,
14.4.2, D9 (17)**9.1.2 SIMULTANEOUS CONTACTS**

Two players may touch the ball at the same moment.

9.1.2.1 When two teammates touch the ball simultaneously, it is counted as two hits (with the exception of blocking).

14.2

If they reach for the ball but only one of them touches it, one hit is counted.

If players collide, no fault is committed.

9.1.2.2 When two opponents touch the ball simultaneously over the net and the ball remains in play, the team receiving the ball is entitled to another three hits. If such a ball goes "out", it is the fault of the team on the opposite side.**9.1.2.3** If simultaneous hits by two opponents over the net lead to an extended contact with the ball, play continues.

9.1.2.2

9.1.2.4 If the ball hits the antenna after simultaneous hits by two opponents over the net, the rally should be replayed.**9.1.3 ASSISTED HIT**

Within the playing area, a player is not permitted to take support from a teammate or any structure/object in order to hit the ball.

However, a player who is about to commit a fault (touch the net or interfere with an opponent, etc.) may be stopped or held back by a team-mate.

9.2 CHARACTERISTICS OF THE HIT		
9.2.1	The ball may touch any part of the body.	
9.2.2	The ball must not be caught or thrown. It can rebound in any direction.	9.3.3
9.2.2.1	Simultaneous Contacts: The ball may touch various parts of the body, provided that the contacts take place simultaneously.	9.2.1
9.2.2.2	Consecutive contacts: At the first hit of the team, provided it is not made overhand with fingers) consecutive contacts are permitted provided that the contacts occur during one action During the first hit of the team if it is played overhand using fingers, the ball may NOT contact the fingers/ hands consecutively, even if the contacts occur during one action.	9.3.4
9.2.2.3	However, at blocking, consecutive contacts may be made by one or more players, provided that they occur during one action;	14.2
9.2.2.4	Extended contacts: In defensive action of a hard driven ball, the ball contact can be extended momentarily even if an overhand finger action is used.	
9.3 FAULTS IN PLAYING THE BALL		
9.3.1	FOUR HITS: a team hits the ball four times before returning it.	9.1, D9 (18)
9.3.2	ASSISTED HIT: a player takes support from a teammate or any structure/ object in order to hit the ball within the playing area.	9.1.3
9.3.3	CATCH: the ball is caught and/or thrown; it does not rebound from the hit. (Exceptions 9.2.2.1, 9.2.2.2).	9.2.2, D9 (16)
9.3.4	DOUBLE CONTACT: a player hits the ball twice in succession or the ball contacts various parts of his/her body in succession.	9.1.1, 9.2.2.2, D9 (17)
10 BALL AT THE NET		
10.1 BALL CROSSING THE NET		
10.1.1	The ball sent to the opponent's court must go over the net within the crossing space. The crossing space is the part of the vertical plane of the net limited as follows:	D4a
10.1.1.1	below, by the top of the net;	
10.1.1.2	at the sides, by the antennae, and their imaginary extension;	
10.1.1.3	above, by the ceiling or structure (if any).	

- | | | |
|---|--|---|
| 10.1.2 | The ball that has crossed the net plane to the opponent's free zone totally or partly through the external space, may be played back within the team hits, provided that: | 9.1, D4b |
| 10.1.2.1 | The ball when played back crosses the vertical plane of the net again totally, or partly through the external space on the same side of the court.

The opponent team may not prevent such action. | D4b |
| 10.1.3 | The ball is "out" when it crosses completely the lower space under the net. | |
| 10.1.4 | A player, however, may enter the opponents' court in order to play the ball before it passes outside the crossing space, or before it crosses completely the lower space. | 10.1.3 |
| 10.2 BALL TOUCHING THE NET | | |
| | While crossing the net, the ball may touch it. | 10.1.1 |
| 10.3 BALL IN THE NET | | |
| 10.3.1 | A ball driven into the net may be recovered within the limits of the three team hits. | 9.1 |
| 10.3.2 | If the ball rips the mesh of the net or tears it down, the rally is cancelled and replayed. | |
| 11 PLAYER AT THE NET | | |
| 11.1 REACHING BEYOND THE NET | | |
| 11.1.1 | In blocking, a player may touch the ball beyond the net, provided that he/she does not interfere with the opponent's play, before the latter's attack hit. | 14.1, 14.3 |
| 11.1.2 | After an attack hit, a player is permitted to pass his/her hand beyond the net, provided that the contact has been made within his/her own playing space. | |
| 11.2 PENETRATION INTO THE OPPONENT'S SPACE, COURT AND/OR FREE ZONE | | |
| 11.2.1 | A player may enter into the opponent's space, court and/or free zone, provided that this does not interfere with the opponent's play. | 10.1.4 |
| 11.3 CONTACT WITH THE NET | | |
| 11.3.1 | Contact with the net by a player between the antennae, during the action of playing the ball, is a fault.

The action of playing the ball includes (among others) take-off, hit (or attempt) and landing safely, ready for a new action. | 11.4.3,
22.3.2.3.c,
26.3.2.2,
D3 |

- 11.3.2 Players may touch the post, ropes, or any other object outside the antennae, including the net itself, provided that it does not interfere with the play (except Rule 9.1.3).
- 11.3.3 When the ball is driven into the net, causing it to touch an opponent, no fault is committed.

11.4 PLAYER'S FAULTS AT THE NET

- 11.4.1 A player touches the ball in the opponent's space before the opponent's attack hit.
- 11.4.2 A player interferes with the opponent's play while penetrating into the opponent's space under the net.
- 11.4.3 A player interferes with play by (amongst others):
- touching the net between the antennae or the antenna itself during his/her action of playing the ball,
 - using the net between the antennae as a support or stabilizing aid
 - creating an unfair advantage over the opponent by touching the net
 - making actions which hinder an opponent's legitimate attempt to play the ball,
 - catching/holding on to the net

Any player close to the ball as it is played, and who is him/herself trying to play it, is considered in the action of playing the ball, even if no contact is made with it.

However, touching the net outside the antenna is not to be considered as a fault (except for Rule 9.1.3.)

D9 (20)

11.3.1, D3

12 SERVICE

The service is the act of putting the ball into play by the correct serving player placed in the service zone.

12.1 FIRST SERVICE IN A SET

- 12.1.1 The first service of a set is executed by the team determined by the toss.

6.3.2, 7.1

12.2 SERVICE ORDER

- 12.2.1 The players must follow the service order recorded on the score sheet.
- 12.2.2 After the first service in a set, the player to serve is determined as follows:
- 12.2.2.1 when the serving team wins the rally, the player who served before, serves again.
- 12.2.2.2 when the receiving team wins the rally, it gains the right to serve and the player who did not serve last time will serve.

12.3	AUTHORIZATION OF THE SERVICE	
	The 1 st referee authorizes the service, after having checked that both teams are ready to play and that the server is in possession of the ball.	D9 (1)
12.4	EXECUTION OF THE SERVICE	
12.4.1	The ball shall be hit with one hand or any part of the arm after being tossed or released from the hand(s).	D9 (10)
12.4.2	Only one toss or release of the ball is allowed. Moving the ball in the hands is permitted.	
12.4.3	The server may move freely within the service zone. At the moment of the service hit or take-off for a jump service, the server must not touch the court (the end line included) or the ground outside the service zone. His/her foot may not go under the end line. After the hit, he/she may step or land outside the service zone, or inside the court. If the line moves because of the sand pushed by the server, it is not considered a fault.	1.4.2, D9 (22), D10 (4)
12.4.4	The server must hit the ball within 5 seconds after the 1 st referee whistles for service.	D9 (11)
12.4.5	A service executed before the referee's whistle is cancelled and repeated.	D9 (23)
12.4.6	If the ball, after having been tossed or released by the server, lands without being touched or caught by the server, it is considered as a service.	
12.4.7	No further service attempt will be permitted.	
12.5	SCREENING	D9 (12)
12.5.1	A player of the serving team must not prevent the opponent, through individual screening, from seeing the service hit AND the flight path of the ball.	D5
12.5.2	A player of the serving team makes a screen by waving arms, jumping or moving sideways during the execution of the service, in order that both the service hit and the flight path of the ball are hidden until the ball reaches the vertical plane of the net. Should either be visible to the receiving team this is not a screen.	D5
12.6	FAULTS MADE DURING THE SERVICE	
12.6.1	Serving faults The following faults lead to a change of service. The server:	
12.6.1.1	violates the service order,	12.2, D9 (13)
12.6.1.2	does not execute the service properly.	12.4

12.6.2 Faults after the service hit

After the ball has been correctly hit, the service becomes a fault if the ball:

- 12.6.2.1 touches a player of the serving team or fails to cross the vertical plane of the net completely through the crossing space; D9 (19)
- 12.6.2.2 goes “out”; 8.4, D9 (15)
- 12.6.2.3 passes over a screen D5

13 ATTACK HIT

13.1 CHARACTERISTICS OF THE ATTACK HIT

- 13.1.1 All actions which direct the ball towards the opponent, with the exception of service and block, are considered as attack hits.
- 13.1.2 An attack-hit is completed the moment the ball completely crosses the vertical plane of the net or is touched by an opponent.
- 13.1.3 Any player may carry out an attack-hit at any height, provided that his/her contact with the ball has been made within the player’s own playing space (except Rule 13.2.4, 13.2.5 below). 13.2.4, 13.2.5

13.2 FAULTS OF THE ATTACK HIT

- 13.2.1 A player hits the ball within the playing space of the opposing team. 13.1.2, D9 (20)
- 13.2.2 A player hits the ball “out”. 8.4, D9 (15)
- 13.2.3 A player completes an attack-hit using an open-handed finger action or if using finger tips that are not rigid and together. D9 (21)
- 13.2.4 A player completes an attack hit on the opponent’s service, when the ball is entirely higher than the top of the net. D9 (21)
- 13.2.5 A player completes an attack-hit using an overhand pass which has a trajectory not perpendicular to the line of the shoulders. The exception is when the player is attempting to set to his or her teammate. D9 (21)

14 BLOCK

14.1 BLOCKING

- 14.1.1 Blocking is the action of players close to the net to intercept the ball coming from the opponent by reaching higher than the top of the net, regardless of the height of the ball contact. At the moment of the contact with the ball, a part of the body must be higher than the top of the net.

14.1.2 Block Attempt

A block attempt is the action of blocking without touching the ball.

14.1.3 Completed Block

A block is completed whenever the ball is touched by a blocker.

D6

14.1.4 Collective Block

A collective block is executed by two players close to each other, and is completed when one of them touches the ball.

14.2 BLOCK CONTACT

Consecutive (quick and continuous) contacts may occur by one or more blockers provided that the contacts are made during one action. These are counted as only one team hit. These contacts may occur with any part of the body.

9.1.1, 9.2.3

14.3 BLOCKING WITHIN THE OPPONENT'S SPACE

In blocking, the player may place his/her hands and arms beyond the net, provided that this action does not interfere with the opponent's play. Thus, it is not permitted to touch the ball beyond the net before an opponent has executed an attack hit.

13.1.1

14.4 BLOCK AND TEAM HITS

14.4.1 A blocking contact is counted as a team hit. The blocking team will have only two more hits after a blocking contact.

14.4.2 The first hit after the block may be executed by any player, including the one who has touched the ball during the block.

14.5 BLOCKING THE SERVICE

To block an opponent's service is forbidden.

D9 (12)

14.6 BLOCKING FAULTS

14.6.1 The blocker touches the ball in the OPPONENT'S space before the opponent's attack hit.

14.3, D9 (20)

14.6.2 Blocking the ball in the opponent's space from outside the antenna.

14.6.3 A player blocks the opponent's service.

D9 (12)

14.6.4 The ball is sent "out" off the block.

D9 (24)

CHAPTER 5 INTERRUPTIONS, DELAYS AND INTERVALS

See Rules

15 INTERRUPTIONS

An interruption is the time between one completed rally and the 1st referee's whistle for the next service.

The only **regular game** interruptions are TIME-OUTS.

D9 (4)

15.1 NUMBER OF REGULAR GAME INTERRUPTIONS

Each team may request a maximum of one time-out per set.

15.2 SEQUENCE OF REGULAR GAME INTERRUPTIONS

- 15.2.1 Request for time-out by both teams may follow one another, within the same interruption.
- 15.2.2 There are no substitutions.
- 15.2.3 It is not permitted to request any regular game interruption after having had a request rejected and sanctioned by a delay warning during the same interruption (i.e. before the end of next completed rally).

15.3 REQUEST FOR REGULAR GAME INTERRUPTIONS

Regular game interruptions may be requested only by the captain.

15.4 TIME-OUTS AND TECHNICAL TIME-OUTS

- 15.4.1 Time-out requests must be made by showing the corresponding hand signal, when the ball is out of play and before the whistle for service. All requested time-outs last for 30 seconds
- 15.4.2 **For FIVB, World and Official Competitions, in sets 1 and 2, one additional 30-second "Technical Time-Out" is applied automatically when the sum of the points scored by the teams equals 21 points. The length of the Time-Outs and Technical Time-Outs could be adjusted if the FIVB approves such request based on a request from the Organizer.**

D9 (4)

- 15.4.3 In the deciding (3rd) set, there are no “Technical Time-Outs”; only one time-out of 30 seconds duration may be requested by each team.
- 15.4.4 During all regular interruptions (including Technical Time Outs) and set intervals, players must go to the designated players’ area. **15.5, 16.1**

15.5 IMPROPER REQUESTS

Among others, it is improper to request a time-out:

- 15.5.1 during a rally or at the moment of, or after the whistle to serve, **6.1.3**
- 15.5.2 by a non-authorized team member,
- 15.5.3 after having exhausted the authorized time-outs. **15.1**
- 15.5.4 Any further improper request in the same match by the same team constitutes a delay. **D9 (25)**

16 GAME DELAYS

16.1 TYPES OF DELAYS

An improper action of a team that defers resumption of the game is a delay and includes, among others:

- 16.1.1 prolonging time-outs, after having been instructed to resume the game;
- 16.1.2 repeating an improper request; **15.5**
- 16.1.3 delaying the game (12 seconds shall be the maximum time from the end of a rally to the whistle for service under normal playing conditions);
- 16.1.4 delaying the game by a team member.

16.2 DELAY SANCTIONS

- 16.2.1 “*Delay warning*” and “*delay penalty*” are team sanctions.
- 16.2.1.1 Delay sanctions remain in force for the entire match.
- 16.2.1.2 All delay sanctions are recorded on the score sheet.
- 16.2.2 The first delay in the match by a team member is sanctioned with a “DELAY WARNING”. **D9 (25), D7b**
- 16.2.3 The second and subsequent delays of any type by any member of the same team in the same match constitute a fault and are sanctioned with a “DELAY PENALTY”: a point and service to the opponent. **D9 (25), D7b**
- 16.2.4 Delay sanctions imposed before or between sets are applied in the following set.

17 EXCEPTIONAL GAME INTERRUPTIONS

17.1 INJURY/ ILLNESS

17.1.1 Should a serious accident occur while the ball is in play, the referee must stop the game immediately and permit medical assistance to enter the court.

The rally is then replayed.

17.1.2 An injured/ill player is given a maximum of 5 minutes recovery time. The referee must authorize the properly accredited medical staff to enter the playing court to attend the player. Only the 1st referee may authorize a player to leave the playing area without penalty. When the treatment has been completed or if no treatment can be provided, play must resume. The 1st referee will whistle and request the player to continue. At this time, only the player can judge whether he/she is fit to play.

If the player does not recover or return to the playing area at the conclusion of the recovery time, his/her team is declared incomplete.

In extreme cases, the doctor of the competition can oppose the return of an injured player.

Note: the recovery time will begin when the properly accredited medical staff member(s) of the competition arrives at the playing court to attend to the player. In the event that no accredited medical staff is available or in cases where the player chooses to be treated by his/her own medical personnel, the time will begin from the moment the recovery time was authorized by the referee.

6.4.3, 7.3.1

17.2 EXTERNAL INTERFERENCE

If there is any external interference during the game, the play has to be stopped and the rally is replayed.

17.3 PROLONGED INTERRUPTIONS

17.3.1 If unforeseen circumstances interrupt the match, the 1st referee, the organizer and the Control Committee, if there is one, shall decide the measures to be taken to re-establish normal conditions.

17.3.2 Should one or several interruptions occur not exceeding 4 hours in total, the match is resumed with the score acquired, regardless of whether it continues on the same playing court or another playing court.

17.3.3 Should one or several interruptions occur, exceeding 4 hours in total, the whole match shall be replayed.

18 INTERVALS AND CHANGE OF COURTS/SWITCHES

18.1 INTERVALS

18.1.1 An interval is the time between sets. All intervals last one minute.

During this period of time, the change of courts (if requested) and service order of the teams on the score sheet are made.

D9 (3)

During the interval before a deciding set, the referees carry out a toss in accordance with Rule 7.1.

18.2 COURT SWITCHES

18.2.1 The teams switch after every 7 points (Set 1 and 2) and 5 points (Set 3) played.

D9 (3)

18.2.2 During court switches the teams must change immediately without delay.

If the court switch is not made at the proper time, it will take place as soon as the error is noticed.

The score at the time that the court switch is made remains the same.

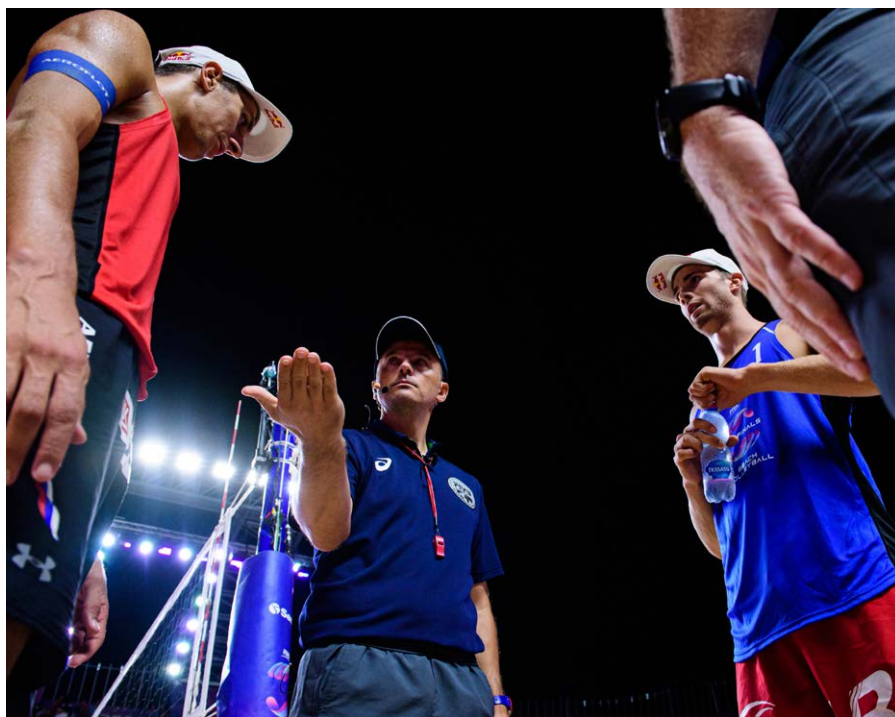

CHAPTER 6 PARTICIPANTS' CONDUCT

See Rules

19 REQUIREMENTS OF CONDUCT

19.1 SPORTSMANLIKE CONDUCT

19.1.1 Participants must know the "Official Beach Volleyball Rules" and abide by them.

19.1.2 Participants must accept referees' decisions with sportsmanlike conduct, without disputing them.

In case of doubt, clarification may be requested only through the captain.

19.1.3 Participants must refrain from actions or attitudes aimed at influencing the decisions of the referees or covering up faults committed by their team.

5.1.2.1

19.2 FAIR PLAY

19.2.1 Participants must behave respectfully and courteously in the spirit of FAIR PLAY, not only towards the referees, but also towards other officials, the opponent, teammates and spectators.

19.2.2 Communication between team members during the match is permitted.

5.2.3.4

20 MISCONDUCT AND ITS SANCTIONS

20.1 MINOR MISCONDUCT

Minor misconduct offences are not subject to sanctions. It is the 1st referee's duty to prevent the teams from approaching the sanctioning level.

5.1.2, 21.3

This is done in two stages:

Stage 1: by issuing a verbal warning through the captain;

Stage 2: by use of a YELLOW CARD to a team member. This formal warning is not in itself a sanction but a symbol that the team member (and by extension the team) has reached the sanctioning level for the match. It is recorded in the score sheet but has no immediate consequences.

D9 (5)

20.2 MISCONDUCT LEADING TO SANCTIONS	
<p>Incorrect conduct by a team member towards officials, opponents, teammates or spectators is classified in three categories according to the seriousness of the offence.</p>	4.1.1
20.2.1 Rude conduct: acting contrary to good manners or moral principles,	
20.2.2 Offensive conduct: defamatory or insulting words or gestures including any action expressing contempt.	
20.2.3 Aggression: actual physical attack or aggressive or threatening behaviour.	
20.3 SANCTION SCALE	
<p>According to the judgment of the 1st referee and depending on the seriousness of the offence, the sanctions to be applied and recorded on the score sheet are: Penalty, Expulsion or Disqualification.</p>	D7a
20.3.1 Penalty	
<p>For rude conduct or a single repetition of rude conduct in the same set by the same player. On each of the first two occasions, the team is sanctioned with a point and service to the opponents. A third rude conduct by a player in the same set is sanctioned by expulsion. Rude conduct sanctions may, however, be given to the same player in subsequent sets.</p>	D9 (6)
20.3.2 Expulsion	
<p>The first offensive conduct is sanctioned by expulsion. The player who is sanctioned with expulsion must leave the playing area and his/her team is declared incomplete for the set.</p>	6.4.3, 7.3.1, D9 (7)
20.3.3 Disqualification	
<p>The first physical attack or implied or threatened aggression is sanctioned by disqualification. The player must leave the playing area and his/her team is declared incomplete for the match.</p>	6.4.3, 7.3.1, D9 (8)
<p>MISCONDUCT is sanctioned as shown in the sanction scale.</p>	D7a
20.4 MISCONDUCT BEFORE AND BETWEEN SETS	
<p>Any misconduct occurring before or between sets is sanctioned according to the sanction scale and the sanction is applied in the following set.</p>	D7a

20.5	SUMMARY OF MISCONDUCT AND CARDS USED	D9 (5, 6, 7, 8)
	Warning: no sanction – Stage 1: verbal warning Stage 2: symbol Yellow card	20.1
	Penalty: sanction – symbol Red card	20.3.1, D7a
	Expulsion: sanction – symbol Red + Yellow cards jointly	20.3.2, D7a
	Disqualification: sanction – symbol Red + Yellow card separately	20.3.3, D7a



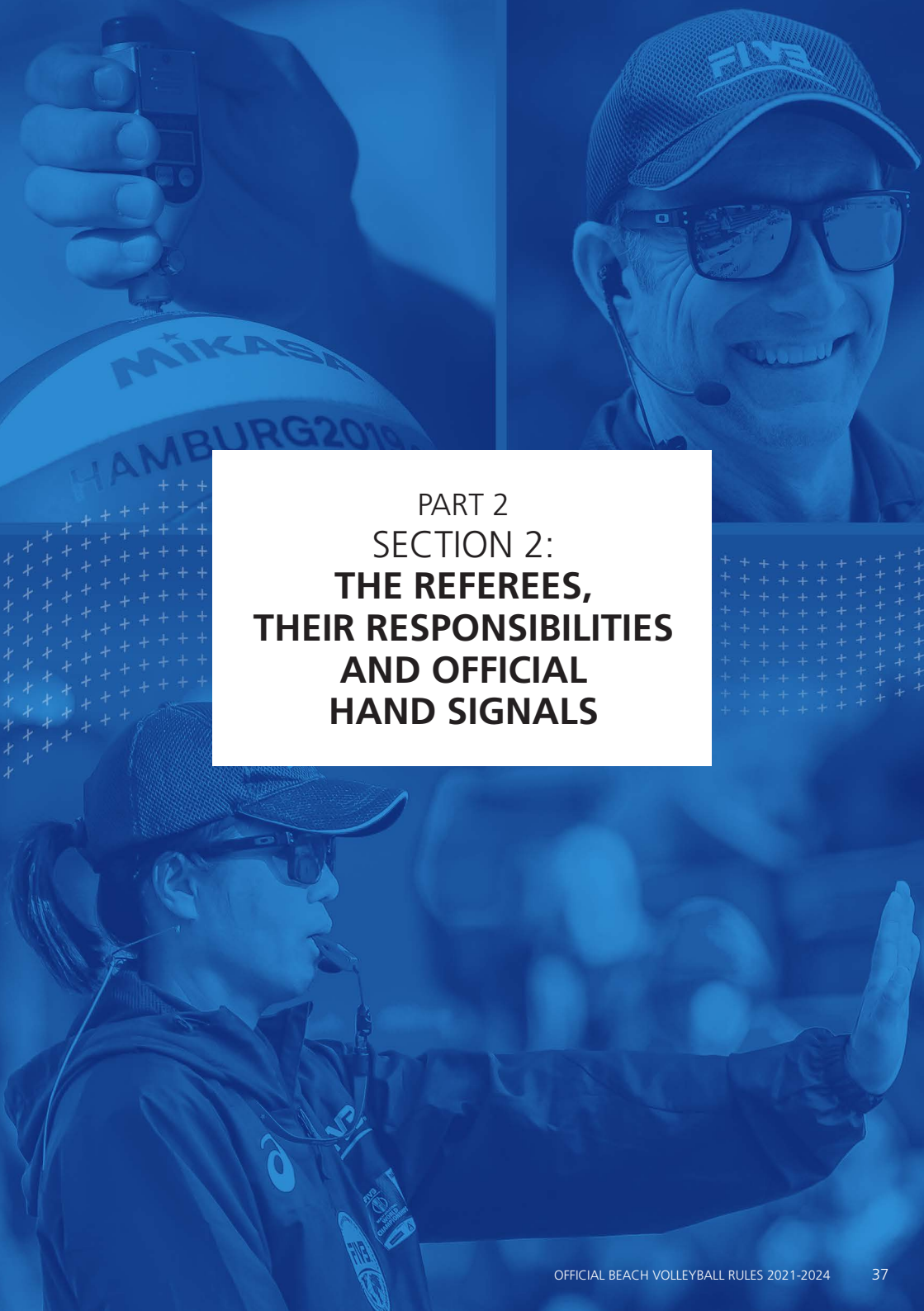

PART 2
SECTION 2:
**THE REFEREES,
THEIR RESPONSIBILITIES
AND OFFICIAL
HAND SIGNALS**

CHAPTER 7 REFEREES

See Rules

21 REFEREEING TEAM AND PROCEDURES

21.1 COMPOSITION

The refereeing team for a match is composed of the following officials:

- the 1st referee, 22
- the 2nd referee, 23
- the challenge referee (where applicable), 24
- the reserve referee (where applicable), 25
- the scorer, 26
- four (two) line judges. 28

Their location is shown in the Diagram 8.

For FIVB, World and Official Competitions, an assistant scorer is compulsory. 27

21.2 PROCEDURES

21.2.1 Only the 1st and 2nd referees may blow a whistle during the match:

21.2.1.1 the 1st referee gives the signal for the service that begins the rally. D9 (1)

21.2.1.2 the 1st or 2nd referee signals the end of the rally, provided that they are sure that a fault has been committed and they have identified its nature.

21.2.2 They may blow the whistle when the ball is out of play to indicate that they authorize or reject a team request.

21.2.3 Immediately after the referee blows the whistle to signal **the completion** of the rally, they have to indicate with the official hand signals: 21.2.1.2, 29.1

21.2.3.1 If the fault is whistled by the 1st referee, he/she will indicate in order:

- a) the team to serve, D9 (2)
- b) the nature of the fault,
- c) the player(s) at fault (if necessary).

21.2.3.2 If the fault is whistled by the 2nd referee, he/she will indicate:

- a) the nature of the fault,
- b) the player at fault (if necessary),
- c) the team to serve following the hand signal of the first referee.

D9 (2)

In this case, the 1st referee does not show **either the nature of the fault or the player at fault, but only the team to serve.**

21.2.3.3 In the case of a double fault both referees indicate in order:

D9 (23)

- a) the nature of the fault,
- b) the players at fault (if necessary),

The team to serve next is then indicated by the 1st referee.

D9 (2)

22 1st REFEREE

22.1 LOCATION

The 1st referee carries out his/her functions standing on a referee's stand located at one end of the net on the opposite side to the scorer. His/her view must be approximately 50 cm above the net.

D1, D8

22.2 AUTHORITY

22.2.1 The 1st referee directs the match from the start until the end. He/she has authority over all members of the refereeing team and the members of the teams.

During the match his/her decisions are final. He/she is authorized to overrule the decisions of other members of the refereeing team, if it is noticed that they are mistaken.

He/she may even replace a member of the refereeing team who is not performing his/her functions properly.

22.2.2 He/she also controls the work of the ball retrievers, and sand levellers.

22.2.3 He/she has the power to decide any matters involving the game, including those not provided for in the Rules.

22.2.4 He/she shall not permit any discussion about his/her decisions.

However, at the request of the captain, the 1st referee will give an explanation on the application or interpretation of the rules upon which he/she has based his/her decision.

If the captain disagrees with the explanation and formally protests, the 1st referee must authorize the commencement of a Protest Protocol.

- 22.2.5 The 1st referee is responsible for determining before and during the match whether the playing area and the conditions meet playing requirements.
- 22.2.6 Depending on the circumstances leading up to an eventual injury/illness of a player, the 1st referee authorizes the medical assistance and initiates the recovery time.

17.1.2

22.3 RESPONSIBILITIES

- 22.3.1 Prior to the match, the 1st referee:
 - 22.3.1.1 inspects the conditions of the playing area, the balls and other equipment;
 - 22.3.1.2 performs the toss with the team captains;
 - 22.3.1.3 controls the teams' warming-up.
- 22.3.2 During the match, he/she is authorized:
 - 22.3.2.1 to issue warnings to the teams;
 - 22.3.2.2 to sanction misconduct and delays;
 - 22.3.2.3 to decide upon:
 - a) the faults of the server and the screen of the serving team;
 - b) the faults in playing the ball;
 - c) the faults above the net, and the faulty contact of the player with the net, primarily (but not exclusively) on the attacker's side;
 - d) the ball crossing completely the lower space under the net;
 - e) the served ball and the 3rd hit passing over or outside the antenna on his/ her side of the court.
- 22.3.3 At the end of the match, he/she checks the score sheet and signs it.

D5

D9 (22)

23 2nd REFEREE

23.1 LOCATION

The 2nd referee performs his/her functions standing outside the playing court near the post, on the opposite side of and facing the 1st referee.

D1, D8

23.2 AUTHORITY

- 23.2.1 The 2nd referee is the assistant of the 1st referee, but has also his/her own range of jurisdiction.

23.3

Should the 1st referee be unable to continue his/her work, the 2nd referee may replace him/her.

- 23.2.2 He/she may, without whistling, also signal faults outside his/her range of jurisdiction, but must not insist upon them to the 1st referee.
- 23.2.3 He/she controls the work of the scorer(s).
- 23.2.4 He/she reports any misconduct to the 1st referee.
- 23.2.5 He/she authorizes the time-outs and court switches, controls the duration of such and rejects improper requests. D9 (3, 4)
- 23.2.6 He/she checks the number of time-outs used by each team and reports to the 1st referee and the players concerned after completion of their time-out.
- 23.2.7 In the case the 1st referee authorizes medical assistance to a player, he/she assists in the process, including managing the recovery time. 17.1.2
- 23.2.8 He/she checks during the match that the balls still meet the requirements of the regulations.
- 23.2.9 He/she conducts the toss between sets 2 and 3 if the 1st Referee is not able to do it. He/she then must pass all relevant information to the scorer.

23.3 RESPONSIBILITIES

- 23.3.1 At the start of each set, and whenever necessary, the 2nd referee controls the work of the scorer and checks that the correct server has the ball.
- 23.3.2 During the match, the 2nd referee decides, whistles and signals:
- 23.3.2.1 interference due to penetration into the opponent's court and space under the net; 11.2, D9 (22)
- 23.3.2.2 the faulty contact of the player with the net primarily (but not exclusively) on the blocker's side and with the antenna on his/her side of the court; 11.3.1
- 23.3.2.3 the contact of the ball with an outside object; 8.4.2, 8.4.3
D9 (15),
D10 (4)
- 23.3.2.4 the ball that crosses the net totally or partly outside the crossing space to the opponent court or touches the antenna on his/her side of the court, including during service; 8.4.3, 8.4.4,
D3, D4a,
D9 (15)
- 23.3.2.5 the contact of the ball with the sand when the 1st referee is not in position to see the contact;
- 23.3.2.6 the ball recovered completely on the opponent's side under the net. D9 (22)
- 23.3.2.7 the served ball and the 3rd hit passing over or outside the antenna on his/ her side of the court.
- 23.3.3 At the end of the match, he/she checks and signs the score sheet.

24 CHALLENGE REFEREE

For FIVB, World and Official Competitions if the Video Challenge System (VCS) is in use, a Challenge referee is compulsory.

24.1 LOCATION

The Challenge Referee carries out his/her functions in the challenge booth locating in a separate position determined by the FIVB Technical Delegate.

24.2 RESPONSIBILITIES

- 24.2.1 He/she supervises the challenge process and ensures, that it proceeds according to the challenge regulation in force.
- 24.2.2 The Challenge referee shall wear an official referee uniform while performing his/her functions.
- 24.2.3 After the challenge process he/she advises the 1st referee of the nature of the fault.
- 24.2.4 At the end of the match, he/she signs the score sheet.

21.2.3.1 D9 (2)

25 RESERVE REFEREE

For FIVB, World and Official Competitions a Reserve referee is compulsory for all TV matches, and anytime the Video Challenge System (VCS) is in use.

25.1 LOCATION

The Reserve referee carries out his/her functions locating in a separate position determined by the FIVB court layout.

25.2 RESPONSIBILITIES

The Reserve referee is obliged to:

- 25.2.1 Wear an official referee uniform while performing his/her functions.
- 25.2.2 Replace the 2nd referee in case of absence or in case that he/she is unable to continue his/her work or in case that the 2nd referee became the 1st referee.
- 25.2.3 Assist the 2nd referee in keeping the free zone.
- 25.2.4 Bring to the 2nd referee four match balls, immediately after the presentation of the players.
- 25.2.5 Give the 2nd referee a match ball after he/she has finished checking the player at service.

23.2.1

D9

3.3

- 25.2.6 Assist the 1st referee with guiding the work of the sand levellers. 22.2.2
- 25.2.7 In case the Video Challenge System (VCS) is in use, he/she supervises the Scorer in filling in the Challenge System process at the e-scoresheet. 24

26 SCORER

26.1 LOCATION

The scorer performs his/her functions seated at the scorer's table on the opposite side of the court from and facing the 1st referee. D1, D8

26.2 RESPONSIBILITIES

The scorer fills in the score sheet according to the Rules, cooperating with the 2nd referee.

He/she uses a buzzer or other sound device to notify irregularities or give signals to the referees on the basis of his/her responsibilities.

- 26.2.1 Prior to the match and set, the scorer:
- 26.2.1.1 registers the data of the match and teams, according to procedures in force and obtains the signatures of the captains;
- 26.2.1.2 records the service order of each team.
- 26.2.2 During the match, the scorer:
- 26.2.2.1 records the points scored;
- 26.2.2.2 controls the serving order of each team and indicates any error before the service hit;
- 26.2.2.3 records the time-outs, checking the number of such, and informs the 2nd referee;
- 26.2.2.4 notifies the referees of a request for time-out that is improper; 15.5
- 26.2.2.5 announces to the referees the court switches and the end of the sets;
- 26.2.2.6 records any sanctions and improper requests;
- 26.2.2.7 records all other events as instructed by the 2nd referee, i.e. recovery time, prolonged interruptions, external interference, etc.;
- 26.2.2.8 controls the interval between sets:
- 26.2.3 At the end of the match, the scorer;
- 26.2.3.1 records the final result;

- 26.2.3.2 in the case of a protest, with the previous authorization of the 1st referee, writes or permits the captain concerned to write on the score sheet a statement on the incident being protested;
- 26.2.3.3 signs the score sheet, before he/she obtains the signatures of the team captains and then the referees.

5.1.2.1, 5.1.3.2

27 ASSISTANT SCORER

27.1 LOCATION

The assistant scorer performs his/her functions seated beside the scorer at the scorer's table.

D1, D8

27.2 RESPONSIBILITIES

He/she assists with the administrative duties of the scorer's work.

Should the scorer become unable to continue his/her work, the assistant scorer substitutes for the scorer.

27.2.1 Prior to the match and set, the assistant scorer;

27.2.1.1 checks that all information displayed at the scoreboard(s) is correct,

27.2.2 During the match, the assistant scorer;

27.2.2.1 indicates the serving order of each team by displaying a sign numbered 1 or 2 corresponding to the player to serve and,

27.2.2.2 indicates by use of the buzzer any error to the referees immediately;

27.2.2.3 operates the manual scoreboard on the scorer's table;

27.2.2.4 checks that the scoreboards agree;

27.2.2.5 starts and ends the timing of the Technical Time-outs;

27.2.2.6 if necessary, updates the reserve score sheet and gives it to the scorer;

27.2.3 At the end of the match, the assistant scorer;

27.2.3.1 signs the score sheet.

28 LINE JUDGES

28.1 LOCATION

If only two line judges are used, they stand at the corners of the court closest to the right hand of each referee, diagonally at 1 to 2 m from the corner.

Each one of them controls both the end line and side line on his/her side.

D1, D8

For FIVB, World and Official Competitions, if four line judges are used, they stand in the free zone at 1 to 3 m from each corner of the court, on the imaginary extension of the line that they control.

28.2 RESPONSIBILITIES

- 28.2.1 The line judges perform their functions by using flags (40 x 40 cm), to signal: **D10**
- 28.2.1.1 the ball “in” and “out” whenever the ball lands near their line(s). (Note: it is primarily the line judge closest to the path of the ball who is responsible for the signal); **8.3, 8.4
D10 (1, 2)**
- 28.2.1.2 the touches of “out” balls by the team receiving the ball; **8.4, D10 (3)**
- 28.2.1.3 the ball touching the antenna, the served ball and the third hit of the team crossing the net outside the crossing space, etc.; **8.4.3, 8.4.4,
10.1.1, D4a,
D10 (4)**
- 28.2.1.4 any player (except the server) stepping outside of his/her court at the moment of the service hit; **7.4, 12.4.3,
D10 (4)**
- 28.2.1.5 the foot faults of the server; **12.4.3, D10 (4)**
- 28.2.1.6 any contact with the top 80 cm of the antenna on their side of the court by any player during his/her action of playing the ball or interfering with the play; **11.3.1, 11.4.4,
D3, D10 (4)**
- 28.2.1.7 the ball crossing the net outside the crossing space into the opponent’s court or touching the antenna on his/her side of the court. **10.1.1, D4a,
D10 (4)**
- 28.2.1.8 the block touches during the rally.
- 28.2.2 At the first referee’s request, a line judge must repeat his/her signal.

29 OFFICIAL SIGNALS

29.1 REFEREES’ HAND SIGNALS

The referees will indicate with the official hand signal the reason for their whistle (the nature of the fault whistled or the purpose of the interruption authorized). The signal has to be maintained for a moment and, if it is indicated with one hand, the hand corresponds to the side of the team which has made the fault or the request.

D9

29.2 LINE JUDGES’ FLAG SIGNALS

The line judges must indicate with the official flag signal the nature of the fault called, and maintain the signal for a moment.

D10





PART 2
SECTION 3:
DIAGRAMS



DIAGRAM 1: THE PLAYING AREA

Relevant Rules: 1, 22.1, 23.1, 26.1, 27.1, 28.1

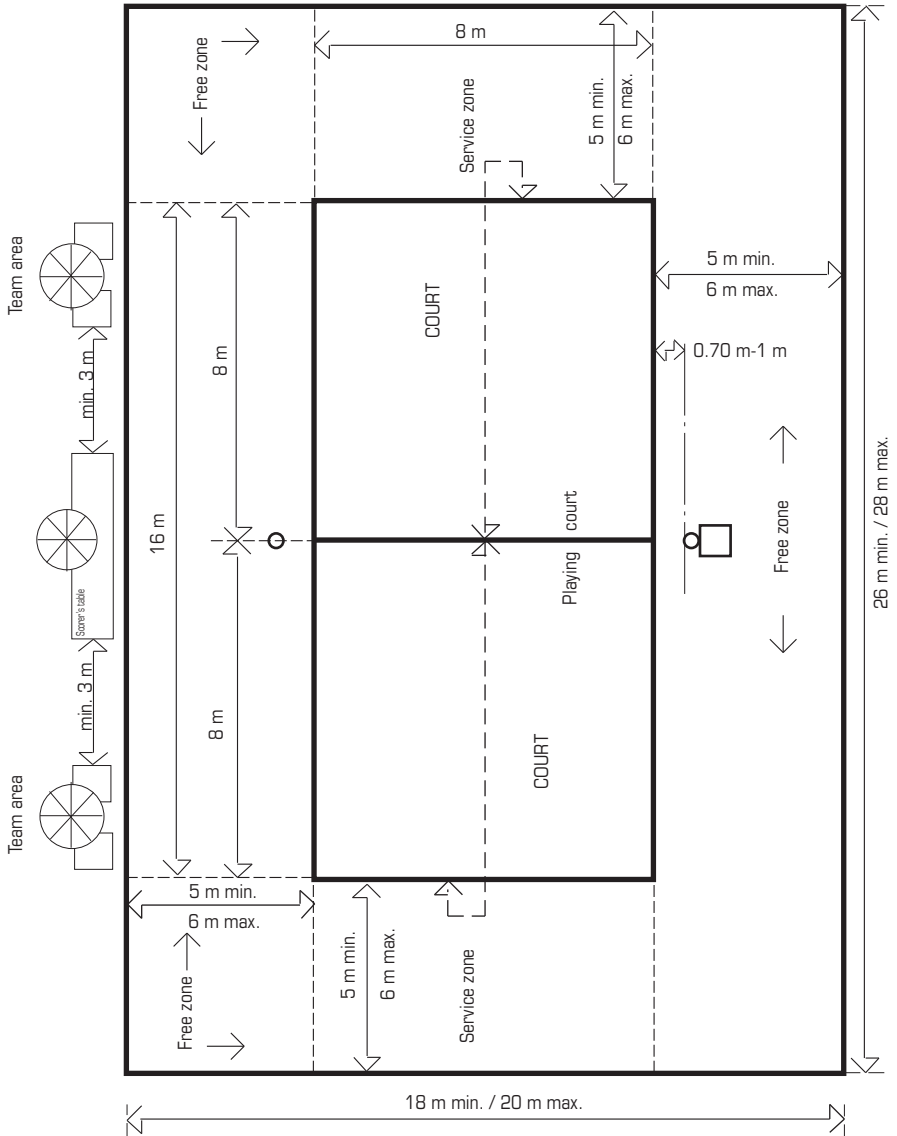

DIAGRAM 2: THE PLAYING COURT

Relevant Rules: 1.1, 1.3, 2.5

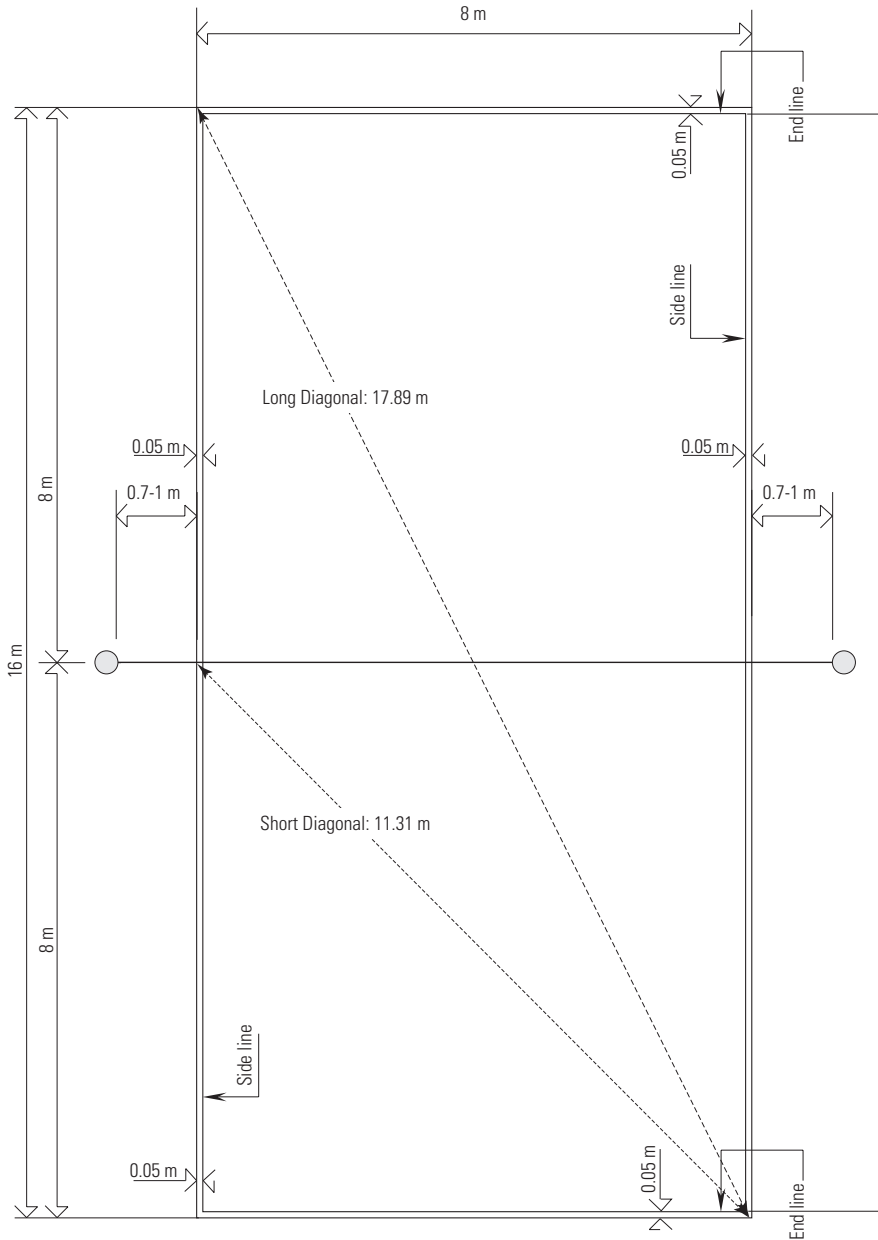
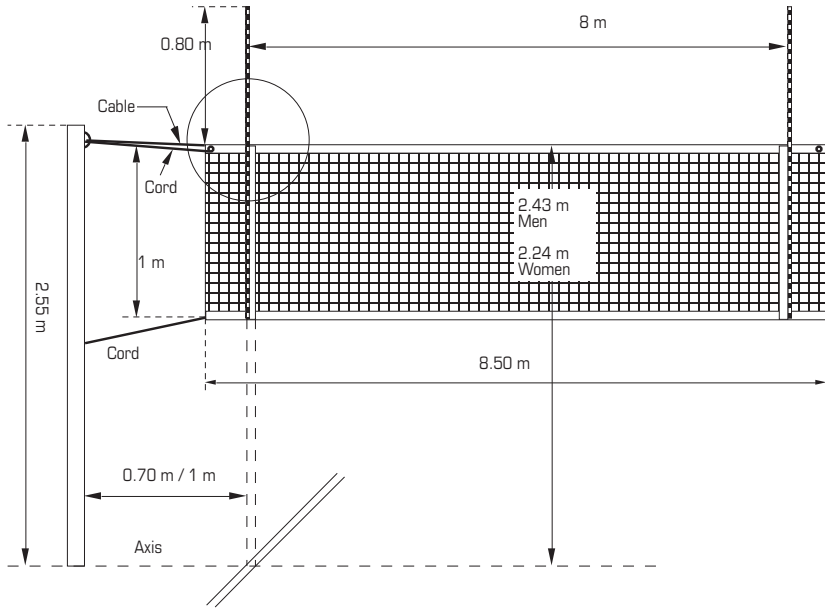

DIAGRAM 3: DESIGN OF THE NET

Relevant Rules: 2, 8.4.3



For FIVB, World and Official Competitions, the net may be adjusted according to 2.1 above.

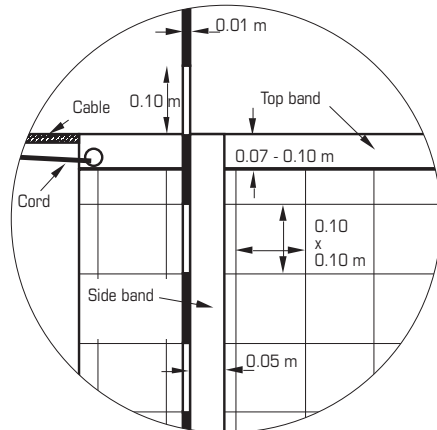
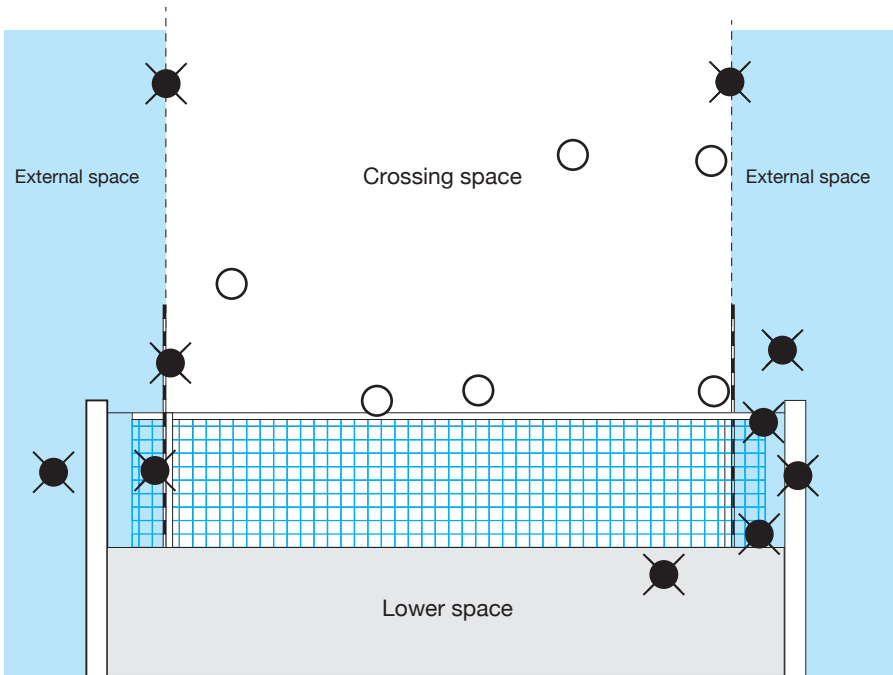

DIAGRAM 4a: BALL CROSSING THE VERTICAL PLANE OF THE NET TO THE OPPONENT COURT

Relevant Rules: 8.4.3, 8.4.4, 8.4.5, 10.1.1, 23.3.2.4, 28.2.1.3, 28.2.1.7



- ⊗ = Fault
- = Correct crossing

DIAGRAM 4b: BALL CROSSING THE VERTICAL PLANE OF THE NET TO THE OPPONENT FREE ZONE

Relevant Rules: 10.1.2, 10.1.2.1

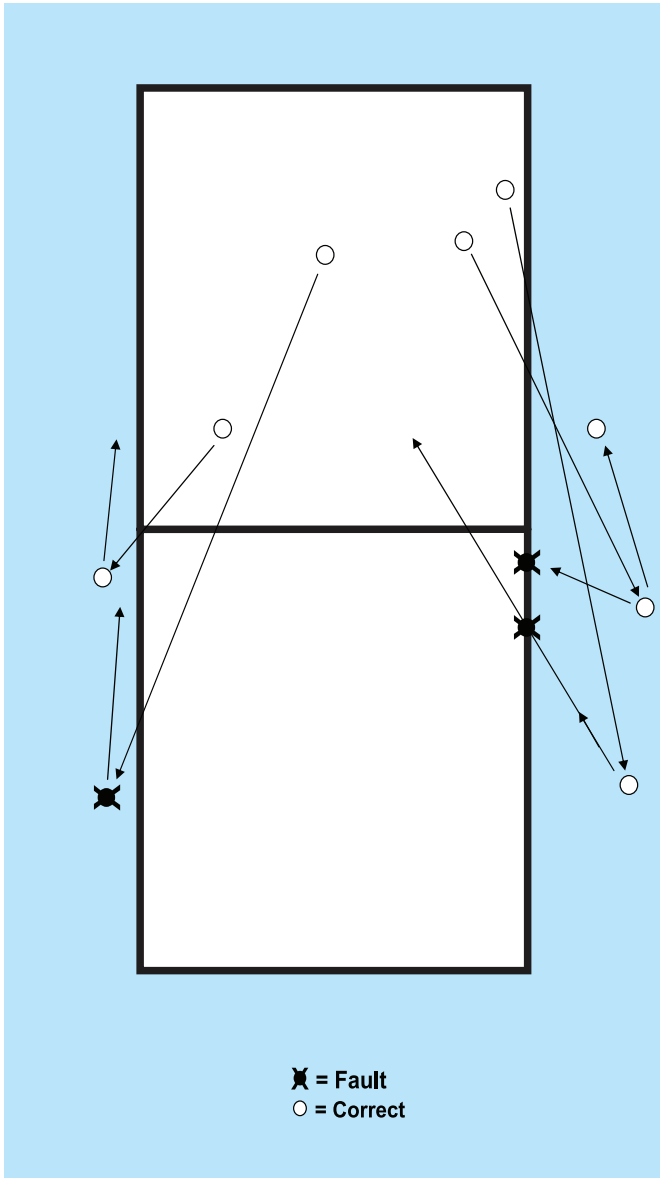

DIAGRAM 5: SCREEN

Relevant Rules: 12.5.1, 12.5.2, 12.6.2.3, 22.3.2.3

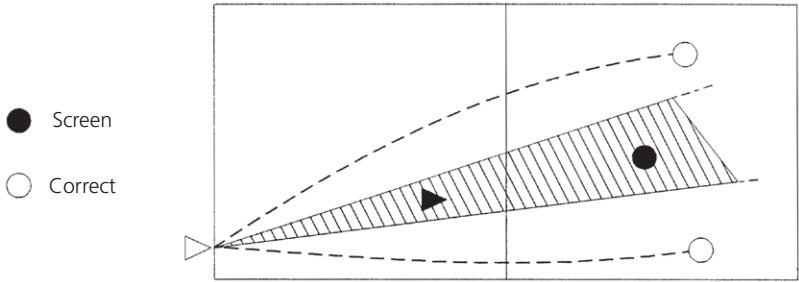

DIAGRAM 6: COMPLETED BLOCK

Relevant Rule: 14.1.3

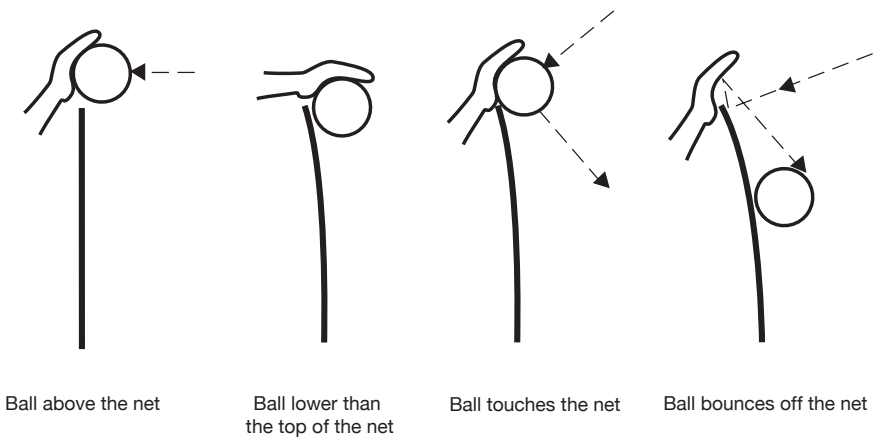

DIAGRAM 7: DETERRENTS AND SANCTIONS

7a: MISCONDUCT WARNING AND SANCTIONS SCALE AND THEIR CONSEQUENCES

Relevant Rules: 20.3, 20.4, 20.5

CATEGORIES	OCCURRENCE	OFFENDER	SANCTION	CARDS	CONSEQUENCE
MINOR MISCONDUCT	Stage 1	Any member	Not considered as sanction	None	Prevention only
	Stage 2			Yellow	
	repetition any time		Considered as rude conduct	as below	as below
RUDE CONDUCT (same set)	First	Any member	Penalty	Red	A point and service to the opponent
	Second	Same member	Penalty	Red	A point and service to the opponent
	Third	Same member	Expulsion	Red + Yellow jointly	Team declared incomplete for the set
RUDE CONDUCT (new set)	First	Any member	Penalty	Red	A point and service to the opponent
OFFENSIVE CONDUCT	First	Any member	Expulsion	Red + Yellow jointly	Team declared incomplete for the set
	Second	Same member	Disqualification	Red + Yellow separately	Team declared incomplete for the match
AGGRESSION	First	Any member	Disqualification	Red + Yellow separately	Team declared incomplete for the match

7b: DELAY SANCTIONS SCALE AND CONSEQUENCES

Relevant Rules: 16.2.2, 16.2.3

CATEGORIES	OCCURRENCE	OFFENDER	DETERRENT or SANCTION	CARDS	CONSEQUENCE
DELAY	First	Any member of the team	Delay Warning	Hand signal No. 25 with Yellow card	Prevention – no penalty
	Second and subsequent	Any member of the team	Delay Penalty	Hand signal No. 25 with Red card	A point and service to the opponent

DIAGRAM 8: LOCATION OF REFEREEING TEAM AND THEIR ASSISTANTS

Relevant Rules: 3.3, 21.1, 22.1, 23.1, 26.1, 27.1, 28.1

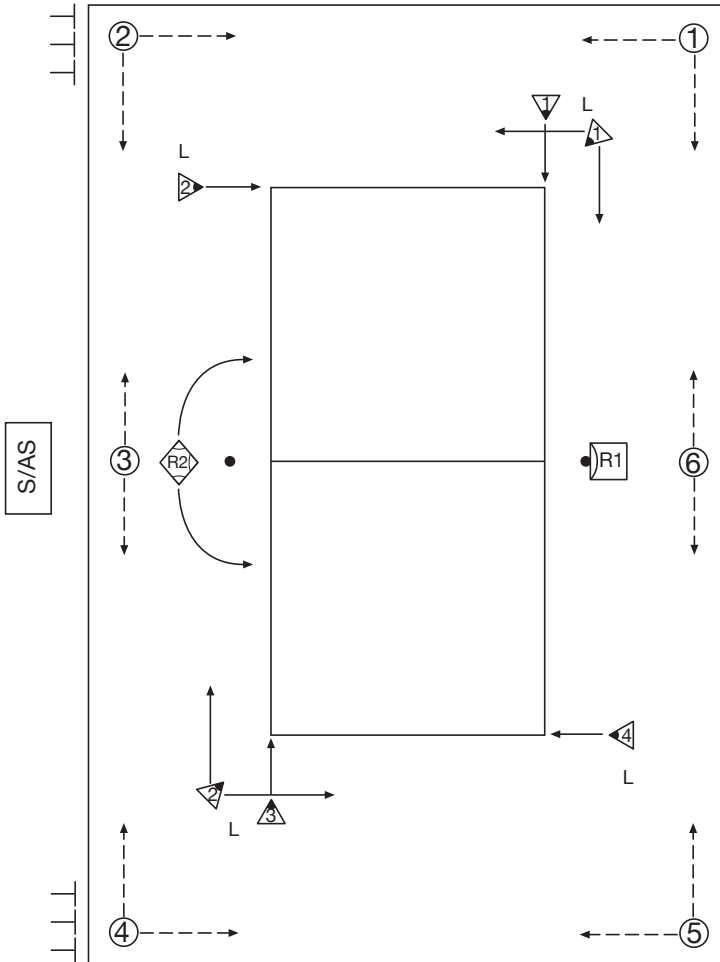

- R1 = First Referee
- ◆ R2 = Second Referee
- S/AS = Scorer/Assistant Scorer
- ▶ L = Lines Judges (numbers 1-4 or 1-2)
- ④ = Ball Retrievers (numbers 1-6)
- ┌ = Sand Levelers

DIAGRAM 9: REFEREES' OFFICIAL HAND SIGNALS

Legend:



Referee(s) who must show the signal according to their regular responsibilities



Referee(s) who show the signal in special situations

1 AUTHORISATION TO SERVE

Relevant Rules: 12.3, 21.2.1.1

Move the hand to indicate direction of service

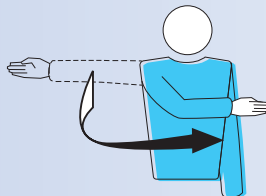

F

2 TEAM TO SERVE

Relevant Rules: 12.3, 21.2.3.1a, 21.2.3.2c, 21.2.3.3c

Extend the arm to the side of team that will serve

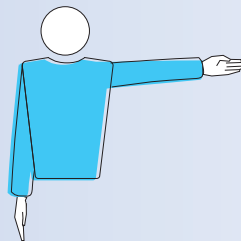

F S

3 CHANGE OF COURTS

Relevant Rules: 18.2, 23.2.5

Raise the forearms front and back and twist them around the body

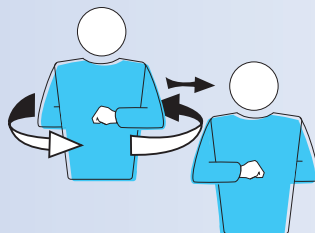

F S

4 TIME-OUT

Relevant Rules: 15, 23.2.5

Place the palm of one hand over the fingers of the other, held vertically (forming a T) and then indicate the requesting team

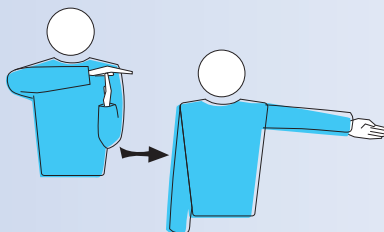

F S

5 MISCONDUCT WARNING

Relevant Rules: 20.1, 20.5

Show a yellow card for warning

F

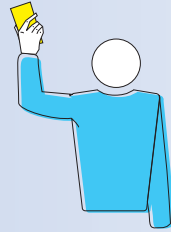

6 MISCONDUCT PENALTY

Relevant Rules: 20.3.1, 20.5

Show a red card for penalty

F

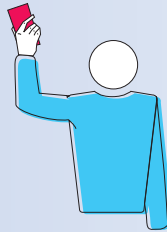

7 EXPULSION

Relevant Rules: 20.3.2, 20.5

Show both cards jointly for expulsion

F

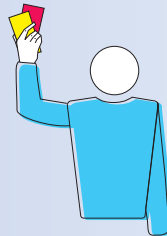

8 DISQUALIFICATION

Relevant Rules: 20.3.3, 20.5

Show red and yellow cards separately for disqualification

F

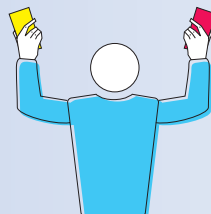

9 END OF SET (OR MATCH)

Relevant Rules: 6.2, 6.3

Cross the forearms in front of the chest, hands open



F

10 BALL NOT TOSSED OR RELEASED AT THE SERVICE HIT

Relevant Rule: 12.4.1

Lift the extended arm, the palm of the hand facing upwards

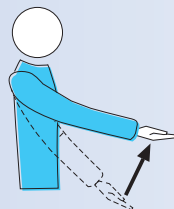

F

11 DELAY IN SERVICE

Relevant Rule: 12.4.4

Raise five fingers, spread open



F

12 BLOCKING FAULT OR SCREENING

Relevant Rules: 12.5, 14.5, 14.6.3

Raise both arms vertically, palms forward

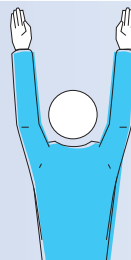

F

13 POSITIONAL OR ROTATIONAL FAULT

Relevant Rules: 7.7.1, 12.6.1.1

Make a circular motion with the forefinger

F S



14 BALL "IN"

Relevant Rules: 6.1.1.1, 8.3

Point the arm and fingers toward the floor

F S

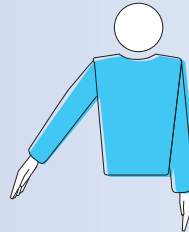

15 BALL "OUT"

Relevant Rules: 8.4.1, 8.4.2, 8.4.3, 8.4.4, 12.6.2.2, 13.2.2

Raise the forearms vertically, hands open, palms towards the body

F S

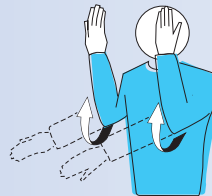

16 CATCH

Relevant Rules: 6.1.2, 9.3.3, 22.3.2.3b

Slowly lift the forearm, palm of the hand facing upwards

F



17 DOUBLE CONTACT

Relevant Rules: 6.1.2, 9.1.1, 9.3.4, 22.3.2.3b

Raise two fingers, spread open

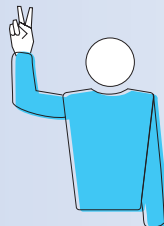

F S

18 FOUR HITS

Relevant Rule: 9.3.1

Raise four fingers, spread open

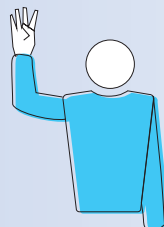

F

19 NET TOUCHED BY PLAYER – SERVED BALL TOUCHES THE NET BETWEEN THE ANTENNAE AND DOES NOT PASS THE VERTICAL PLANE OF THE NET

Relevant Rule: 12.6.2.1

Indicate the relevant side of the net with the corresponding hand

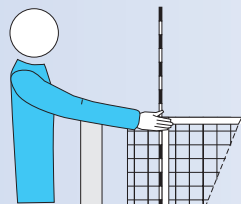

F S

20 REACHING BEYOND THE NET

Relevant Rules: 11.4.1, 13.2.1

Place a hand above the net, palm facing downwards

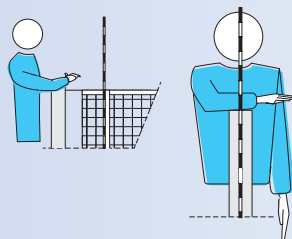

F

21 ATTACK HIT FAULT

- by a player who completes an attack-hit using an open-handed finger action, or if using finger tips that are not rigid and together.
- by a player who completes an attack hit on the opponent's service, when the ball is entirely higher than the top of the net.
- by a player who completes an attack-hit using an overhand pass which has a trajectory not perpendicular to the line of the shoulders, except when he/she is attempting to set to his or her teammate.

Relevant Rules: 13.2.3, 13.2.4, 13.2.5

Make a downward motion with the forearm, hand open

F



22 INTERFERENCE DUE TO PENETRATION INTO THE OPPONENT'S COURT AND SPACE UNDER THE NET BALL CROSSES COMPLETELY THE LOWER SPACE UNDER THE NET THE SERVER TOUCHES THE COURT (THE END LINE INCLUDED) OR THE GROUND OUTSIDE THE SERVICE ZONE UNLESS FOR THE SERVER, THE PLAYER STEPS OUTSIDE HIS/HER COURT AT THE MOMENT OF THE SERVICE HIT

Relevant Rules: 8.4.5, 11.2.1, 12.4.3, 23.3.2.1, 23.3.2.6

Point to the court under the net or to the respective line

F S



23 DOUBLE FAULT AND REPLAY

Relevant Rules: 6.1.2.2, 12.4.5

Raise both thumbs vertically

F S



24 BALL TOUCHED

Relevant Rule: 14.6.4

Brush with the palm of one hand the fingers of the other, held vertically

F



25 DELAY WARNING/DELAY PENALTY

Relevant Rules: 15.5.5, 16.2.2, 16.2.3

Cover the wrist with a yellow card (warning)
or with a red card (penalty)

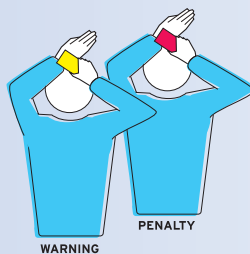

F

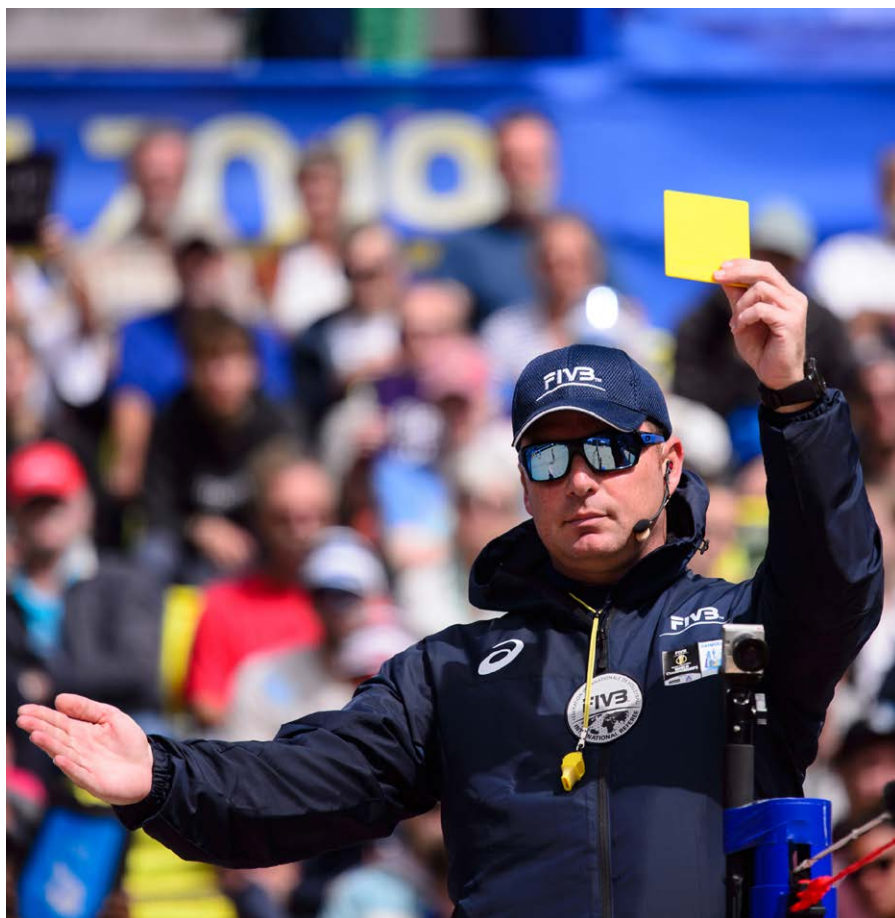
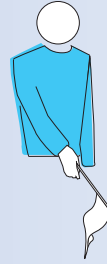

DIAGRAM 10: LINE JUDGES' OFFICIAL FLAG SIGNALS

1 BALL "IN"

Relevant Rules: 8.3, 28.2.1.1

Point down with flag



L

2 BALL "OUT"

Relevant Rules: 8.4.1, 28.2.1.1

Raise flag vertically

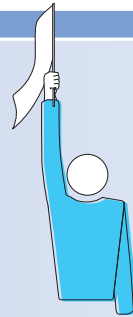

L

3 BALL TOUCHED

Relevant Rule: 28.2.1.2

Raise flag and touch the top with the palm of the free hand



L

4 CROSSING SPACE FAULTS, BALL TOUCHED AN OUTSIDE OBJECT, OR FOOT FAULT BY ANY PLAYER DURING SERVICE

Relevant Rules: 8.4.2, 8.4.3, 8.4.4, 12.4.3, 28.2.1.3, 28.2.1.4, 28.2.1.5, 28.2.1.6, 28.2.1.7

Wave flag over the head and point to the antenna or the respective line

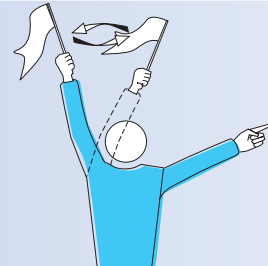

L

5 JUDGEMENT IMPOSSIBLE

Raise and cross both arms and hands in front of the chest



L





PART 3
DEFINITIONS

PROTOCOL

The series of events before the start of the match, including the toss, the warming-up session, presentation of the teams and referees described in the Specific Competition Handbook.

COMPETITION/ CONTROL AREA

The Competition/ Control Area is a corridor around the playing court and free zone, which includes all spaces up to the outer barriers or delimitation fence. See diagram/fig 1a.

ZONES

These are sections within the playing area (i.e. playing court and free zone) as defined for a specific purpose (or with special restrictions) within the rule text. These include: Service Zone & Free Zone.

LOWER SPACE

This is the space defined as its upper part by the bottom of the net and the cord joining it to the posts, at the sides by the posts, and the bottom by the playing surface.

CROSSING SPACE

The crossing space is defined by:

- The horizontal band at the top of the net
- The antennae and their extension
- The ceiling

The ball must cross to the opponent's COURT through the crossing space.

EXTERNAL SPACE

The external space is in the vertical plane of the net outside of the crossing and lower spaces.

UNLESS BY AGREEMENT OF FIVB

This statement recognizes that while there are regulations on the standards and specification of equipment and facilities, there are occasions when special arrangements can be made by FIVB in order to promote the game of Beach Volleyball or to test new conditions.

FIVB STANDARDS

The technical specifications or limits as defined by FIVB to the manufacturers of equipment.

FAULT

- a) A playing action contrary to the rules.
- b) A rule violation other than a playing action.

FIRST HIT OF THE TEAM

There are three cases, when the playing action is considered first hit of the team:

- Service reception
- Receiving an attack of the opponent team
- Playing the ball rebounding from opponent's block

RALLY POINT

This is the system of scoring a point whenever a rally is won.

TECHNICAL TIME-OUT

This special mandatory time-out is, in addition to time-outs, to allow the promotion of Beach Volleyball, analysis of the play and to allow additional commercial opportunities. Technical Time-Outs are mandatory for FIVB, World and Official competitions.

INTERVAL

The time between sets. The change of courts in the third (deciding) set is not to be regarded as an interval.

INTERFERING

Any action which will create an advantage against the opponent team or any action which prevents an opponent from playing the ball.

OUTSIDE OBJECT

An object or a person which while outside the playing court or close to the limit of the free playing space provides an obstruction to the flight of the ball. For example: Overhead lights, the referee's chair, TV equipment, scorer's table, and net posts. Outside objects do not include the antennae since they are considered as the part of the net.

BALL RETRIEVERS

These are personnel whose job it is to maintain the flow of the game by rolling the ball to the server between rallies.

SAND LEVELLERS (RAKERS)

These court assistants use long rakes or long poles with flattened ends to smooth out the sand especially around the court lines and across the central axis of the court between the posts.



INDEX

A		F	
Additional Equipment.....	15	Fair play	34
Antennae.....	14	Faults in playing the ball	24
Attack hit.....	28	Faults made during the service	27
Authorization of the service.....	27	Faults of the attack hit.....	28
B		First Referee	39
Ball at the net.....	24	– Authority.....	39
Ball crossing the net	24	– Location	39
Ball “in”	22, 59, 63	– Responsibilities	40
Ball in play.....	22	First service in a set.....	26
Ball in the net.....	25	Forbidden objects.....	17
Ball “out”	22, 59, 63	Four-ball system	15
Ball out of play.....	22	G	
Ball touching the net.....	25	Game delays	31
Balls	15	Game interruptions	30
Block.....	28, 53	H	
Block and team hits.....	29	Height of the net.....	13
Block contact	29	I	
Blocking.....	28, 58	Improper request.....	31
Blocking faults.....	29	Injury/ Illness.....	32
Blocking the service.....	29	Interruptions	30
Blocking within the opponent’s space.....	29	Intervals	33
C		Intervals and court switches.....	33
Captain	17	L	
Challenge Referee	42	Lighting.....	13
– Location	42	Line judges.....	44, 63-64
– Responsibilities	42	– Location	44
Change of courts/switches	33, 56	– Responsibilities	45
Change of equipment	17	Line judges’ flag signals.....	45, 63-64
Characteristics of the attack hit	28	Lines on the court	13
Characteristics of the hit.....	24	Location of the team	16
Contact with the net.....	25	M	
D		Minor misconduct	34
Default and incomplete team	20	Misconduct and its sanctions.....	34
Delay sanctions	31	Misconduct before and between sets	35
Dimensions	12	Misconduct leading to sanctions.....	35
E		N	
Equipment	16	Net and posts.....	13
Exceptional game interruption.....	32	Number of regular game interruptions	30
Execution of the service.....	27		
External interference	32		

O	
Official signals.....	45, 56-62, 63-64
Official warm-up session	21
P	
Player's faults at the net.....	26
Playing area.....	12, 48
Playing surface.....	12
Playing the ball.....	23
Positions.....	21
Positional fault	21
Posts	15
Prolonged interruptions.....	32
R	
Reaching beyond the net.....	25, 60
Refereeing team.....	38, 55
– Procedures	38
– Responsibilities	40, 41, 42, 43, 44, 45
Referees' hand signals.....	45, 56-62
Requirements of conduct	34
Reserve Referee.....	42
– Location	42
– Responsibilities	42
Rotational fault	59
S	
Sanction cards.....	36, 54, 57
Sanction scale	35, 54
Scorer	43
– Location	43
– Responsibilities	43
Screening.....	27, 58
Second Referee	40
– Authority.....	40
– Location	40
– Responsibilities	41
Service	26
Sequence of regular game interruptions.....	30
Service order	21
Service order faults.....	27
Side bands	14
Sportsmanlike conduct.....	34
Standards.....	15
States of play	22
Structure.....	14
Structure of play.....	20

T	
Teams.....	16
Team composition	16
Team hits.....	23, 29
Team leaders	17
Team line-up	21
The toss	20
Time-out and Technical Time-out.....	30
To score a point.....	19
To score a point, win a set and the match...	19
To win a set.....	20
To win the match	20
Types of delays	31
U	
Uniformity of balls.....	15
V	
Video Challenge System.....	42
W	
Weather.....	13
Z	
Zones and areas	13



MEMO

A series of horizontal dotted lines for writing, spanning the width of the page below the "MEMO" header.

FIVB[™]



fivb.com

